

The Impact and mitigation of Climate Change on the building performance of non-residential buildings: Case studies of typical UK supermarkets

Agha Usama Hasan

Student Number: 21445082

A thesis submitted to the University of West London for the degree of PhD

Supervisors:

Professor Ali Bahadori-Jahromi, School of Computing and Engineering

Dr Anastasia Mylona, CIBSE

May 2023

Declaration

I, Agha Hasan, declare that this thesis, 'Impact of current and future climate change on the building performance of non-residential buildings: Case studies of typical 'UK supermarket,' was composed by myself. Therefore, the work contained in this thesis is my own, except where explicitly stated otherwise. In addition, this work has not been submitted to obtain another degree or professional qualification.

Signed: _Agha Hasan_____

Date: __May 2023_____

Contents

Declaration.....	2
Abstract.....	9
LIST OF FIGURES.....	10
LIST OF TABLES.....	12
List of Acronyms/Abbreviations.....	13
Acknowledgements.....	16
List of Publications arising from this thesis.....	17
Chapter 1: Introduction - background and context	18
1.1 Gap knowledge	20
1.2 Purpose and Significance of Research	21
1.1.1 Research Questions	22
1.1.2 Objectives.....	22
1.1.3 Delimitations.....	22
1.1.4 Structure and Layout.....	23
1.1.4.1 Chapter 1 – Introduction to the work.....	23
1.1.4.2 Chapter 2 – Literature Review	23
1.1.4.3 Chapter 3 – Methodology.....	23
1.1.4.4 Chapter 4 - Investigating the Potential Impact of Future Climate Change on UK Supermarket Building Performance.....	24
1.1.4.5 Chapter 5 - A comparative study of supermarket building performance under current and future weather conditions: UK case study.....	24
1.1.4.6 Chapter 6 – Reaching nZEB: Impact of EEMs on a newly built supermarket in London.....	24
1.1.4.7 Chapter 7 – Comparative analysis of the operational vs embodied carbon of three construction methods of a UK-based supermarket.....	24
1.1.4.8 Chapter 8 – Investigating the future climate impact of modern construction methods (MMCs) on the building performance of UK supermarkets: Case study Embodied carbon of operational primary building services.	24
1.1.4.9 Chapter 9 – Conclusion.	25
Chapter 2: Literature Review	26
2.1 Climate change and the Built environment.....	26
2.2 Development of climate change models	28
2.3 CO ₂ emissions and Energy consumption in non-residential buildings.....	30
2.31 Summary of the Synthesis Report of the IPCC Sixth Assessment Report (AR6) SPM and climate change data on commercial buildings	31

2.3.2 CO2 Emissions and Energy Consumption in the UK supermarket industry	33
2.4 Building Modelling and Simulation	37
2.4.1 Building modelling energy performance gap.....	38
2.4.2 Studies on performance gap and estimation of building energy performance.....	40
2.4.3 Bridging Energy Performance Gap.....	42
2.5 Effect of climate change on building energy performance and Emissions.....	42
2.6 CIBSE weather data sets (Design Summer Year (DSY)/Test Reference Year (TRY)).....	43
2.7 Building Life Cycle Assessment (LCA).....	44
2.7.1 Sustainability Assessment Certification Systems.....	45
2.7.2 LEED Certification.....	46
2.7.2.1.1 Green Building LCA credits in LEED.....	46
2.7.2.1.2 LEED Version 4.1	47
2.7.1.3 LEED v4.1 Building Design and Construction (BD+C) Material and Resources (MR) Building Life-cycle Impact Reduction.....	48
A complete LCA of any building/project must be completed with up to three credits (additional one credit available for exemplary improvement) depending on impact reduction. A summary is available in Table 8 (One Click LCA® software. 2022):.....	
2.7.1.4 Environmental Impacts while calculating credits	48
2.7.2.1 BREEAM Certification.....	49
2.7.2.2. BREEAM Version 6	50
2.7.2.3 BREEAM assessment criteria	50
2.7.2.4 Credits Criteria	50
2.7.2.5 The argument for two significant schemes (LEED vs BREEAM)	51
2.7.3 EDGE.....	52
2.7.3.1 Level of certification	53
2.7.3.2 EDGE Certification Guide	54
2.7.3.3 EDGE incentives	54
2.7.3.4 EDGE 3.0 Version (BETA).....	55
CHAPTER 3: Methodology.....	57
3.1 Research Paradigm	57
3.1.1 Research Design.....	57
3.1.2 Ethical Considerations.....	59
3.1.3 Building simulation software and Modelling.....	60
3.1.4 TAS building simulation software.	61
3.1.5 TAS Building Simulation Principle	61

3.1.6 EDSL TAS 3D Modelling Process.....	62
3.1.7 Thermal Simulation Process.....	63
Chapter 4: Investigating the Potential Impact of Future Climate Change on UK Supermarket Building Performance – Case Study.....	64
4.1 Problem statement.....	64
4.2 Thermal Analysis Simulation (TAS-EDSL) 3D Modelling.....	66
4.3 Modelling Process.....	67
4.4 Simulation Process.....	67
4.5 UK Building Regulation Studio 2013.....	68
4.6 Future Weather Data Simulation Process.....	68
4.7. Results and Discussion of Simulation Modelling London UK supermarket.....	69
4.7.1 Statistical Analysis of the Key Performance Indicators.....	70
4.7.1.1 Total Annual Energy Consumption Variation.....	73
4.7.1.2 Total Carbon Dioxide (CO ₂) Emissions Variation.....	73
4.7.2 Annual Electricity Grid Comparison Analysis.....	73
4.7.2.1 Percentage of Cooling Demand Variation.....	74
4.7.2.2 Percentage of Heating Demand Reduction.....	74
4.7.3 Analysis and Comparison of Significant Parameters under the Worst-Case Scenario.....	75
4.7.3.1 Analysis and Comparison of External Temperature.....	75
Chapter 5: A comparative study of supermarket building performance under Current and future weather conditions: UK case study.....	76
5.1 Problem statement.....	76
5.2. Building energy performance simulation software.....	78
5.2.3 3D Modelling of Thermal Analysis Simulation (TAS-EDSL):.....	78
5.2.4 Weather files used in simulation packages.....	78
5.2.5 City Selection Criteria.....	79
5.2.6 Simulation Process Research flow.....	80
5.2.7 Simulation (Performance parameter selection for simulation).....	80
5.3 UK Climate Projections (UKCP) Projections:.....	81
5.3.1 Current climate weather data.....	82
5.3.2 Future climate weather data.....	82
5.3.3 Data Collection.....	82
5.4 Results obtained from the cities taken as a case study.....	83
5.4.1 London model.....	83

5.4.1.1 Current weather scenario	83
5.4.1.2 Future weather scenarios	83
5.4.1.3 Energy & CO ₂ emissions	84
5.4.1.4 Heating & Cooling comparison	85
5.4.2 Manchester model.....	86
5.4.2.1 Current weather scenario	86
5.4.2.2 Future weather scenarios	86
5.4.2.3 Energy & CO ₂ emissions	86
5.4.2.4 Heating & Cooling comparison	87
5.4.3 Southampton model	88
5.4.3.1 Current weather scenario	88
5.4.3.2 Future weather scenarios	89
5.4.3.3 Energy & CO ₂ emissions	89
5.4.3.4 Heating & Cooling comparison	90
5.4.4 Norwich model.....	90
5.4.4.1 Current weather scenario:	90
5.4.4.2 Future weather scenarios	91
5.4.4.3 Energy & CO ₂ emissions	91
5.4.4.4 Heating & Cooling comparison	92
5.4.5 Full Multi-city Comparative Analysis.....	93
5.4 Conclusion & Discussion of the Chapter	96
Chapter 6 - A quantitative case study to assess the performance of UK supermarket buildings concerning future climate change and modern construction techniques (MMCs).....	99
6.1 Problem Statement.....	99
6.2 Relationship Between Modern Construction Materials/Methods and Climate Change	100
6.3. Methodology.....	101
6.3.1 LIDL-approved construction methods	101
6.3.2 Thermal Analysis Software (TAS) v9.5.0- Building Energy Modelling:	102
6.3.3 Construction Database – TAS EDSL.....	102
6.3.4 3D Modeller and Building Design.....	102
6.4 Case Study.....	103
6.4.1 Selection of City	104
6.4.2 Building Modelling and Simulation	104
6.5 Results and Discussion:	105

6.6 Conclusions and Future Scope	109
Chapter 7- Reaching the nearly zero energy (nZEB) target: Impact of Energy efficient measures (EEMs) on the operational performance of a newly built London supermarket.....	111
7.1 Problem statement.....	111
7.2 Introduction	112
7.2.1 Background	113
7.2.2 Standards set for Non-residential nZEBs	114
7.3 Methodology.....	117
7.3.1 Case study	117
7.3.2 Modelling Assumptions	119
7.4 Results and Discussions	122
7.4.1 Model validation	122
7.4.2 Implementation of individual EEMs:.....	122
7.4.3 Reaching Close to nZEB Using the best combination of EEMs.	124
7.5 Conclusion.....	126
Chapter 8 - Comparative analysis of the whole life carbon of three construction methods of a UK-based supermarket	127
8.1 Introduction	127
8.1.1 Background & Whole Life Carbon.....	127
8.1.2 Practical Application	130
8.2 Whole Life Carbon in Supermarket Buildings	130
8.2.1 Life Cycle Assessment (LCA).....	131
8.2.1.1 Goal & Scope.....	132
8.3 Methodology.....	133
8.3.1 Case Study	133
8.3.2 Life Cycle Inventory (LCI).....	134
8.3.3 Calculation	136
8.3.3.1 Embodied Carbon (A1-A5, C1-C4).....	136
8.3.3.2 Operational Carbon (B6-B7).....	138
8.4 Results & Discussion	140
8.4.1 Embodied Carbon	140
8.4.2 Operational Energy/Carbon	141
8.4.2.1 Current Scenario	141
8.4.2.2 Future Scenario (20-year period).....	142

8.4.2.2 Verifying simulation results.	143
8.4.3 Benchmarking results.....	143
8.4.4 Whole Life Carbon.....	144
8.5 Conclusions	145
Chapter 9 - Findings Leading to Recommendations/Conclusions	147
9.1 Summary of Work	147
9.2 Summary of Findings.....	148
9.3 Implications of the Findings	149
9.4 Limitations.....	151
9.6 Conclusion.....	152
References:	154

Abstract

The UK Government's Climate Change Act (CCA) aims to achieve a net zero greenhouse gas emission by 2050. Supermarkets, being among the most energy-intensive non-residential buildings, play a pivotal role in this endeavour. This research delves into the influence of climate change on supermarket buildings, exploring methodologies to mitigate its impact and assessing its effects on operational energy and carbon emissions. The United Nations has emphasized the built environment's significant contribution to global CO₂ emissions, necessitating urgent action. Using a quantitative approach, this study employs the TAS – EDSL software to simulate energy consumption, carbon emission, and building regulations for various supermarket case studies. The research also evaluates the performance of these buildings across different UK climates and emission scenarios, incorporating EU Zebra2020 tool metrics.

The primary challenge encountered was the scarcity of literature specifically targeting the UK supermarket industry in the context of climate change. The research underscores the importance of balancing energy consumption, carbon emissions, and future climate adaptations, especially given the industry's nZEB target by 2050.

The findings of this study serve as a beacon for all non-residential buildings, bridging the knowledge gap between climate change, building futureproofing, and emission reduction strategies. The research underscores the importance of long-term planning, continuous monitoring of energy-intensive buildings, and the holistic approach of reducing emissions across a building's lifespan. This research aims to guide policymakers and building designers in future-proofing structures, emphasizing the need for energy-efficient measures and the integration of renewable technologies. The overarching goal is to foster the creation of sustainable, climate-resilient buildings for future generations.

LIST OF FIGURES

Figure 1: Various geographical locations under scientific research to investigate the effects of climate change on the energy consumption and carbon emissions of buildings (Ciancio et al. 2020).....	27
Figure 2. The global average surface temperature change from 2006 to 2100.	29
Figure 3a. Energy intensity for total floor area (Foster et al. 2018).	36
Figure 4. Building life cycle stages.....	45
Figure 5: Guide to EDGE Certification.	54
Figure 6: EDGE certification incentives.	55
Figure 7: Process of TAS EDSL with stages.	60
Figure 8: Annual carbon dioxide (CO ²) emissions in the representative concentration pathways (RCPs) and the associated scenario categories.....	64
Figure 9:(a-d). Typical 3-D model building geometry (TAS-EDSL).....	66
Figure 10(a–c). Baseline model building geometry (thermal analysis simulation (TAS) software).	69
Figure 11: Building Heat Transfer Zones.	70
Figure 12: A 3D visualization of the building showing all the zones with their respective temperatures.	70
Figure 13. Schematic summary of the pathways of how climate change impacts environmental effects on buildings and subsequently on building’s occupants (McMichael, Woodruff & Hales 2006).	76
Figure 14. Research flow for preparation to the pre-modelling stage.	80
Figure 15. Research flow for supermarkets investigation.	82
Figure 16. Annual Energy Consumption and CO ₂ Breakdown.	83
Figure 17. Annual energy and CO ₂ consumption comparison (the 2050s vs 2080s).	84
Figure 18. Annual heating and cooling energy consumption comparison (the 2050s vs 2080s).	85
Figure 19. Annual Energy Consumption and CO ₂ Breakdown.	86
Figure 20. Annual energy and CO ₂ consumption comparison (the 2050s vs 2080s).	87
Figure 21. Annual heating and cooling energy consumption comparison (the 2050s vs 2080s).	87
Figure 22. Annual Energy Consumption and CO ₂ Breakdown.	88
Figure 23. Annual energy and CO ₂ consumption comparison (the 2050s vs 2080s).	89
Figure 24. Annual heating and cooling energy consumption comparison (the 2050s vs 2080s).	90
Figure 25. Annual Energy Consumption and CO ₂ Breakdown.	91
Figure 26. Annual energy and CO ₂ consumption comparison (the 2050s vs 2080s).	92
Figure 27. Annual energy and CO ₂ consumption comparison (the 2050s vs 2080s).	92
Figure 28: Energy usage division by percentage in the UK non-domestic buildings (Steadman et al. 2020).	100
Figure 29: Model P1, P2 and P3 - Operational Energy/Carbon emissions under current scenario....	106
Figure 30: Model P1, P2 and P3 - Operational Energy/Carbon emissions under High 10 th percentile.	107
Figure 31: Model P1, P2 and P3 - Operational Energy/Carbon emissions under High 50 th	107
Figure 32: Model P1, P2 and P3 - Operational Energy/Carbon emissions under High 90 th scenario.	108
Figure 33: Model P1, P2 and P3 - Operational Energy (KWh/m ²)/Carbon emissions (KgCO ₂ /m ²) under all possible scenarios.	109
Figure 34: Floor plan of the supermarket building.	118
Figure 35: 3-D modelling of floor plan.	118
Figure 36: supermarket building in analysis mode.	119

Figure 37a. London test reference year annual wind rose.	119
Figure 38a. Primary energy consumption with implemented measures.	123
Figure 39a. Effect of combination of EEMs on PEC.....	125
Figure 40: Indicative components of embodied and operational energy over an illustrative building life cycle recreated from (Yohanis & Norto 2002).	129
Figure 41: Breakdown of energy use in a typical supermarket (Target Zero Information Line 2011).	131
Figure 42: LCA stages reproduced from ISO 14040 (British Standards Institution 2006).....	132
Figure 43: Life cycle stages reproduced from BS EN 15978-2011 (Environmental management 2021).	133
Figure 44: 3D model building geometry in TAS – EDSL.....	135
Figure 45: Calculated Embodied Carbon Contribution of models P1, P2, P3.	140
Figure 46: Calculated Embodied Carbon Comparison of models P1, P2, P3, P3' (including timber sequestered carbon).	141
Figure 47: Operational energy and carbon emissions of models P1, P2 and P3 under the current scenario.	142
Figure 48: Operational energy and carbon emissions of models P1, P2, and P3 under the future scenario.	143
Figure 49: The upfront, operational and end-of-life emissions contribution of models P1, P2, P3, P3'.	144
Figure 50: Contributions of the upfront, operational, and end-of-life emissions of models P1, P2, and P3 to the Whole life carbon.	145

LIST OF TABLES

Table 1. Projected change in global mean surface temperature (IPCC 2014).	29
Table 2. Energy intensity of large food stores (BEES 2016).	35
Table 3. Energy consumption of different retailers (Foster et al. 2018).	36
Table 4. Causes of discrepancies between predicted and actual energy performance (Menezes et al. 2012).	39
Table 5. Causes of energy performance gaps in the operational phase of the building (Jradi et al., 2018).	40
Table 6. Categories and points are available in the LEED system.	46
Table 7. LCA credits in LEED.	47
Table 8. Summary of LEED v4.1 (BD+C).	48
Table 9. BREEAM star rating system.	49
Table 10. Elements assessed by building type.	50
Table 11. Overview of certification system (BREEAM vs LEED) (Pacetti 2012).	50
Table 12. Level of Certification (Edge Building 2022).	53
Table 13. Benefits of adopting EDGE certification.	55
Table 14. Total savings using EDGE certification so far.	56
Table 15. Simulation assumptions: building fabric specification.	67
Table 16. Simulation assumptions: building summary specification.	67
Table 17. Energy and CO ₂ emissions summary.	69
Table 18a. Annual energy consumption variation comparison under the 2050s percentile.	70
Table 19. UK regional climates and selected cities.	79
Table 20. Simulation assumptions: building fabric specification.	80
Table 21. Simulation assumptions: building summary specification.	81
Table 22. Construction details: specifications of thermophysical characteristics.	81
Table 23a. Multi-city annual heating consumption (all emissions scenarios).	93
Table 24. Approved design models of different construction methods.	104
Table 25. Baseline TAS results against non-residential nZEB targets	116
Table 26. Selected list of EEMs.	116
Table 27: Building specification - NCM database.	120
Table 28: Thermophysical properties.	121
Table 29: Simulated standard design model for three construction methods of LIDL supermarket buildings using Autodesk® Revit® BIM software: Isometric view of the model.	134
Table 30: Summary of material quantities.	135
Table 31: Table depicting the available embodied carbon factors provided in the EPDs.	136
Table 32: Default value assumed for material transport distance for A4 and C2 stages.	137
Table 33: Simulation assumptions: building summary specification.	138
Table 34: Simulation assumptions: building fabric specifications.	139
Table 35: Calculated Embodied Carbon Contribution of the external wall, roof frame & column components of models P1, P2, and P3.	141

List of Acronyms/Abbreviations

AEI	Average Energy Intensity
ASHRAE	American Society of Heating, the Refrigerating, and Air Conditioning Engineers
BEEM	Building Energy and Environmental Modelling
BEES	Building Energy Efficiency Survey
BIU	BREEAM In-Use
BREEAM	Building Research Establishment's Environmental Assessment method
BRUKL	Building Regulations United Kingdom part-L
CASBEE	Comprehensive Assessment System for Built Environment Efficiency
CCHP	Combined cooling, heating, and power
CFD	Computational Fluid Dynamic
CHP	Combined Heat and Power
CIBSE	Chartered Institution of Building Services Engineers
CIRS	Centre for Interactive Research on Sustainability
COP	Co-efficient of performance (COP)
DCLG	The Department for Levelling Up, Housing, and Communities
DHW	Domestic hot water (DHW)
DSY	Design Summer Year
EDGE	Excellence in Design for Greater Efficiencies'
EDSL	Environmental design solutions limited (EDSL)
EEMs	Energy efficiency measures
	Environmental Impacts
EPC	Energy Performance Certificate
EPCs	Energy performance certificate (EPCs)
EPDB	Energy Performance of Buildings Directive
EUI	Energy use intensity
FM	Facilities managers
GCM	General circulation models (GCM)
GFA	Gross floor area
GHG	Greenhouse gas
GIA	
G-SEED	Green Standard for Energy and Environmental Design
GSHPs	Ground source heat pumps
GWP	Global warming potential
HVAC	Heating Ventilation and Air Conditioning
ICE	Inventory of Carbon and Energy
IEA	International Energy Agency
IFC	International Finance Corporation
IPCC	Intergovernmental Panel on Climate Change
LCA	Life cycle assessment

LEED	Leadership in the Energy and Environmental Design
MVHR	Mechanical Ventilation with Heat Recovery
NCM	Nationwide Calculation Methodology
NREL	National Renewable Energy Laboratory
nZEB	Nearly zero energy building
O+M	Operation plus maintenance
OECD	Organisation for Economic Co-operation and Development
PEC	Primary energy consumption
PROBE	Post-occupancy Review of Buildings and their Engineering
PV	Photovoltaic
RCPs	Representative concentration pathways
RFID	Radio-frequency identification tags
ROI	Return on investment
SCOP	Seasonal Coefficient of Performance (SCOP)
SFA	Sales Floor Area
TAS	Thermal analysis simulation (TAS)
TBD	TAS Building Designer
TMY2	Typical meteorological year 2
TRACI	Tool for the Reduction and Assessment of Chemical and Other
TRY	Test Reference Year
UI	User Interface
UKCP	UK Climate Projections
USGBC	US Green Building Council

I dedicate this thesis to my beloved family - Ammi, Abbu, Maria, Ali, Salma, Sophia, Eshal, Mirha, and Izhaan. To the new members soon to join us, can't wait to welcome you with open arms. Love you all.

Acknowledgements

I would like to begin by expressing my heartfelt gratitude to Allah almighty (Allahu Akbar) for his blessings and guidance in every aspect of my life, both in this world and the hereafter. Alhamdulillah.

I would also like to extend my sincere appreciation to my supervisory team and the project sponsors, Dr Anastasia Mylona and Mark Barthorpe, for their invaluable expertise, feedback, and guidance throughout my study. Their unwavering support and constructive comments have been instrumental in shaping the direction and outcome of my research.

I am especially grateful to my supervisor, Professor Ali Bahadori Jahromi, for his unwavering support and mentorship. His constant availability and unwavering guidance have been indispensable in providing me with the necessary tools to complete my thesis independently. He has also provided me with invaluable experience in lecturing, presenting at conferences, and journal writing. I am truly indebted to him for his support and encouragement during the most challenging phases of my work.

I would like to express my gratitude to everyone who has accompanied me on my academic journey, especially LIDL, providing me with support and data along the way making this possible. Although not all of the supervisory team have remained in contact with me as times moves on, I am grateful for their contributions and wish them well.

I must also acknowledge the unwavering support and prayers of my family back home, especially my parents, whose love and care have been a constant source of inspiration for me. I am fortunate to have siblings who are not only my siblings but also my closest friends, including my older sister, Maria, who encouraged me to pursue this opportunity in the first place, my brother, Ali, who has always been my protector and cheerleader, and my younger sister, Salma, whom I love dearly and has been my confidante throughout my childhood. I am grateful for the latest additions to my family - Sophia and Eshal. They hold a special place in my heart, as do the others who will soon become new members of our family.

Finally, I would like to reflect on my personal journey, which began when I arrived in this country as a refugee, seeking safety and a new beginning for myself and my family. Despite the challenges I faced, including limited resources and imperfect English, I remained determined to pursue my dream of earning a PhD. With the help of Allah almighty and the support of sincere and caring individuals, I completed my Masters with distinction and was accepted into a PhD program. This journey has taught me the value of dedication and perseverance, and I am grateful for the opportunity to share my story and express my appreciation to those who have supported me along the way.

List of Publications arising from this thesis

Hasan, A., Bahadori-Jahromi, A., Mylona, A., Ferri, M. and Tahayori, H. (2020). Investigating the Potential Impact of Future Climate Change on UK Supermarket Building Performance. *Sustainability*, 13(1), p.33. doi:10.3390/su13010033.

Hasan, A., Bahadori-Jahromi, A., Mylona, A., Ferri, M. and Zhang, H. (2022). Comparing building performance of supermarkets under future climate change: UK case study. *Advances in Energy Research*, 8(1), p.73. doi:10.12989/eri.2022.8.1.073.

Mohebbi, G., Hasan, A., Blay-Armah, A., Bahadori-Jahromi, A., Mylona, A. and Barthorpe, M. (2023). Comparative analysis of the whole life carbon of three construction methods of a UK-based supermarket. *Building Services Engineering Research and Technology*, 014362442311610. doi:10.1177/01436244231161070

Hasan, A. U., Bahadori-Jahromi, A., Mylona, A. and Barthorpe, M. (2023). A quantitative case study to assess the performance of UK supermarket buildings in relation to future climate change and modern construction techniques (MMCs). *Engineering Future Sustainability*, 1(1). doi:10.36828/efs.205

Hasan, A.U. and Bahadori-Jahromi, A. (2023). Reaching the nearly zero energy (nZEB) target: Impact of energy efficient measures (EEMs) on operational performance of a newly built London supermarket. 5th International Conference and Exhibition for Science 2023 (ICES2023). New York City: Springer, p.135.

Chapter 1: Introduction - background and context

A well-established fact among the built environment scientific community is that sustainable and energy-efficient construction is becoming increasingly important in today's world. It goes further by concluding that only such buildings will dominate the building sector of the future (Weißenberger, Jensch, & Lang 2014). Over the years, the increase in the world population has forced urbanisation to expand exponentially with increased demand for housing, office space, energy systems, shopping, and supermarkets worldwide. According to the planning policy outlined by the 'Communities and Local Government' (DCLG 2020) department of the UK government, "England is one of the most crowded countries in the world with over 90% of its population living in urban areas covering just 8% of the land area" (DCLG 2020). It points out that the impact of future climate change needs to be addressed immediately, specifically in the UK's urban built environment (Eltges 2010). This changing trend towards sustainable construction methods and green buildings has given rise to a new idea of future-proof buildings of tomorrow.

The impact of CO₂ emissions within the built environment is a cause for alarm for the UK and the world. Moreover, the growing concern over increasing pollution and greenhouse gas (GHG) emissions has initiated a debate among the UK Government and other industry sectors to reduce its environmental impact to ensure a sustainable future (Liobikienė & Butkus 2019; Mikhaylov et al. 2020). While the earth is experiencing rapid climate change, the Intergovernmental Panel on Climate Change (IPCC) puts the human factor at the centre of its reasoning. "There is a very high confidence that the globally averaged net effect of human activities since 1750 has been one of warming" (IPCC 2007). Therefore, the global effort to combat climate change will inevitably rely on improving the energy efficiency of buildings in the coming decades (IEA 2006). As a result, the most recent decade (2010–2019) has been, on average, 0.9 °C warmer across the UK than 1961–1990, with 2019 being 1.1 °C above the 1961–1990 long-term average (Kendon et al. 2020). As for 2019, it was the sixth consecutive year with fewer touches of frost than average and one of the least snowy years on record. Kendon et al. 2020 dictate that the year 2019 was most remarkable for setting four UK high-temperature records, including the following:

- A new record (38.7 °C), 25 July, Cambridge University Botanic Gardens (Cambridge shire).
- A new winter record (21.2 °C), 26 February, Kew Gardens (London); the first-time 20°C was recorded in the UK in a winter month.
- A new December record (18.7 °C), 28 December, Achfary (Sutherland).
- A new February minimum record (13.9 °C), 23 February, Achnagart (Highland).

One piece of research dictates that in Europe, the building sector is the largest energy consumer; it takes 40% of overall energy consumption and produces 36% CO₂, where one-third of this energy consumption results from non-domestic buildings (Shariq & Hughes, 2020). Currently, almost 75% of the building stock in Europe is not energy efficient, and more than 75% of the overall building stock is envisaged to remain in use beyond 2050, especially in the public sector (Li, et al. 2019). Furthermore, even in the UK, the building stock is one of the oldest compared

to Europe, as more than one-third of the dwellings were constructed pre-1945 and one-quarter of the non-residential building stock was constructed pre-1940 (National Energy Efficiency Action Plans (NEEAPs) 2017).

Non-residential property accounts for 13% of the UK-built environment and contributes 10% of CO₂ emissions (PDR 2017). Reducing energy consumption and GHG emissions are one of the most important goals of European policies to achieve a sustainable and long-lasting future (de Alegría Mancisidor et al. 2009).

The building construction sector produces almost 30% of CO₂ emissions in the atmosphere, and at least 60% of these are due to the use of the building during its lifetime, which shows the importance of the built environment in global warming and climate change (de Wilde & Coley 2012). Furthermore, the UK building sector accounts for approximately 3% of total electricity use, and UK supermarkets and similar organisations are responsible for 1% of the total UK GHG emissions (Tassou et al. 2011). This data indicates that this matter requires urgent and effective action to reduce the projected increases in energy consumption and carbon emissions in the building sector, where emissions have not fallen in recent years.

According to one report, the UK has over 87,000 supermarkets operating across the country (USDA 2019). These buildings have high energy use intensity (EUI) due to their increased refrigeration and lighting needs. However, the research of today concludes that operational energy, which is focused on the consumption by building services such as cooling, lighting, heating, and equipment, remains quite a dominant parameter with a total energy consumption of up to 80-90% over building's life cycle energy demand (Ramesh, Prakash, & Shukla, 2010).

Several researchers have investigated the effect of regional geographical climate on the energy consumption and carbon emissions of the supermarkets in the area. A considerable proportion of the buildings in the UK perform quite poorly during the hot weather waves, reinforcing the need for appropriate climate change studies and using future weather files to study the buildings' performance assessment at regular intervals (Nicol & Humphreys 2007). Furthermore, the local weather surrounding any building dictates the energy needs of the building (Ciancio et al. 2018). It can thus be inferred that the regional and local weather patterns will dictate the energy usage and, subsequently, the carbon emissions for the existing buildings in the area (Andrić et al. 2017). Moreover, due to their local weather conditions, these buildings will also dictate the change in their local civil building sector to keep the energy demand low (Olakitan Atanda 2019).

Several measures were experimented upon non-residential buildings to achieve a reduction in greenhouse gases. These measures encompassed a variety of energy efficiency measures (EEMs) chosen for their potential impact, feasibility, and relevance to the UK's non-residential building sector. The study delved into building fabric improvements, focusing on enhanced insulation and materials with superior thermal properties. It also explored advanced lighting systems, integrating energy-efficient solutions like LED technology and smart controls. Advanced Heating, Ventilation, and Air Conditioning (HVAC) systems were investigated for optimized energy consumption. Furthermore, the research emphasized on-site renewable energy generation, integrating solar photovoltaic (PV) panels, Ground Source Heat Pumps (GSHPs), and Combined Heat and Power (CHP) systems. The potential of Combined Cooling, Heating, and Power (CCHP) systems, or trigeneration, was also examined for comprehensive energy management, as cited by various studies (Ríos Fernández & Roqueñí 2018; Berggren et al. 2012; Oliveira et al. 2011; D'Agostino et al. 2021).

Therefore, considering the issues highlighted and a thorough literature review, this research focuses on addressing and exploring the impact of current and future climate change on the building performance of non-residential buildings, specifically supermarkets in the UK, including identifying the effect of the location of the supermarket and the critical design factors which can provide the most significant reduction in energy consumption and greenhouse gas emissions while examining the major sustainability assessment methods. Examining the current ongoing projects regarding the ‘green’ supermarket industry in Europe and around the world, some limited results show the effect of climate change on building performance. However, it mainly targets non-residential buildings such as hotels, hospitals, and prisons. Furthermore, the local/regional weather is integral in deciding the building performance outcome. Each region has a different and unique climate, which is a deciding factor in building performance results. As the supermarkets under study are newly built, they must follow the latest UK building regulations as well as have the store building services (heating, cooling, lighting, domestic hot water) selected from the approved supplier’s list to make the results as close to the real-world conditions as possible. In addition, necessary assumptions are made for the smooth operation of simulations, such as the inclusion of the National Calculation Methodology (NCM), which helps compare the building under research with a ‘notional’ building with similar properties. Similarly, assuming a working calendar helps define the supermarket's operational hours throughout the year. Although the nearly zero energy building (nZEB) concept is relatively recent, environmentalists have tried to incorporate energy efficiency measures (EEMs) and renewable or microgeneration technologies in supermarkets. However, this came with its own set of problems starting with high initial investments, on-site issues, efficiency issues, the latest building regulations, and the unpredictability of costs of new energy-saving technologies. Thus, this research aims to investigate the impact of climate change (current and future) on typical supermarkets all around the UK. It explicitly focuses on energy consumption and greenhouse gas emissions, uses energy efficiency technologies to cater to the increasing emissions, and focuses on the building's cradle-to-grave carbon (embodied/operational) approach.

1.1 Gap knowledge

Upon further research of the literature review, the following areas require further research:

1. Key finding 1: Current weather effect on the typical supermarket building

We are exploring the impact of the current (the 2020s) weather trend on typical supermarket buildings depending upon the location and regional climate of the building in the UK.

2. Key finding 2: Future weather effect on the typical supermarket building

Exploring the impact of the future (the 2050s and 2080s) weather trends on typical supermarket buildings based on the location and regional climate of the building in the UK.

3. Key finding 3: Relation between climate change and the location of supermarkets in the UK

Identifying the effect of climate change at different locations with a focused comparison of North vs South England and observing and highlighting the significant distinctions between the selected locations.

Comparing the first three critical findings with various representative concentration pathways (RCPs) describing several climate futures is possible depending on the volume of greenhouse gases (GHG) emitted in the years. The results will investigate the relation of RCPs with the low, medium, and high emissions per centile of 10th, 50th, and 90th, respectively. The aim is to focus on the results and obtain the supermarket store energy consumption, emissions, cooling, and heating.

4. Key finding 4: Defining and achieving nZEB standards for the UK non-residential buildings

The new concept of nZEB is not fully understood, especially in the UK building industry, and therefore lacks a proper methodology.

5. Key finding 5: Eligibility of set of EEMs to achieve nZEB in a newly built typical UK non-residential building

Investigating an approach with a set of EEMs, for a typical non-residential building to achieve the nZEB standards for a newly built supermarket in the UK

6. Key finding 6: Cradle-to-grave approach of the supermarket building

The literature review lacks the process of establishing a complete cradle-to-grave approach which includes the extraction of the resources required to create the building ('cradle') through its use phase to its ultimate disposal ('grave') or in other words the total amount of embodied energy that the product 'consumes' During its full life cycle.

1.2 Purpose and Significance of Research

The primary objective of this research is to elucidate how supermarkets, along with other non-residential buildings such as commercial or retail structures, are impacted by the impending drastic shifts in climate. The rationale behind generalizing non-residential buildings, including supermarkets and commercial establishments, stems from the observation that these structures often share commonalities in their operational patterns, energy consumption profiles, and occupancy behaviours. While each building type has its unique characteristics, the National Calculation Methodology (NCM) internal conditions for such non-residential buildings tend to exhibit similarities, especially in terms of lighting, heating, cooling, and ventilation demands. This generalization, however, does not overlook the nuances of each building type but provides a broader perspective to address the challenges posed by climate change.

Establishing a quantitative approach to discern the impact on non-residential building performance is paramount. Such insights will empower policymakers and designers to future-proof these structures, emphasizing the construction of nearly zero-energy buildings (nZEBs) by integrating pertinent energy efficiency measures (EEMs).

A comprehensive cradle-to-grave analysis of a supermarket will further reinforce the hypotheses related to the establishment's carbon emissions throughout its lifecycle. Procuring detailed emissions data for every stage of a building's life ensures proactive measures, leading to the creation of sustainable structures with extended longevity. Implementing these modifications signifies a reduced dependency on our dwindling energy resources, diminished emissions, and the provision of cost-effective, eco-friendly solutions for the generations to come.

1.1.1 Research Questions

This research aims to answer the following questions, which have been selected to address the identified gaps in the literature:

1. What is the direct impact of climate change on the building performance of a typical supermarket in the UK?
2. How does the building performance of typical supermarkets compare with each other in different regions of the UK under future climate change?
3. What types of EEMs could be realistically applied to reduce energy consumption and carbon emissions in non-residential buildings to achieve the nZEB standards?
4. What are the future implications of operational vs embodied carbon of building services of a UK-based supermarket?

1.1.2 Objectives

1. To reduce the energy consumption and, subsequently, the carbon footprint of a typical UK supermarket building.
2. To design and model the building performance of a UK supermarket building against The Chartered Institution of Building Services Engineers (CIBSE) current and future weather database and use the data to calculate the effect on building performance located in different regional climates in the UK.
3. To elaborate on the data available regarding nZEB framework for non-residential buildings, emphasizing on high energy performance where minimal energy needs are met predominantly through on-site or nearby renewable sources.
4. To devise a full life cycle assessment (LCA) analysis of supermarket buildings highlighting the carbon emissions 'sink' regions in a 'cradle-to-grave' approach.
5. The main objective of this work is to explore, using the dynamic simulation software TAS-EDSL, how the future of climate change affects the supermarkets of today and what can be done to reduce that impact.

1.1.3 Delimitations

Today's architectural landscape is diverse and intricate, encompassing a wide range of structures designed for various purposes. The built environment includes offices, religious institutes, education centres, industries, leisure parks, retail supermarkets, and more. Each supermarket, given its specific location, has unique energy consumption patterns, regional climate considerations, and other particularities. For instance, certain renewable technologies, like solar photovoltaic modules, might be more suitable for regions in the UK with warmer climates, as these technologies rely on a consistent thermal energy source. Conversely, in other non-residential buildings that aren't supermarkets, while the overarching methodology remains consistent, there are specific limitations. Automated lighting systems might be ideal for areas like warehouses and backroom offices in supermarkets but may not be well-received in main retail spaces or shop floors due to customer preferences. It's crucial to understand that a one-size-fits-all approach isn't viable given the unique characteristics of different buildings. This thesis aims to provide solutions that are both realistic and tailored to specific building types.

The methodology developed applies to supermarkets and certain non-residential buildings with floor plans like supermarkets or retail buildings. Therefore, it is imperative that accurate, reliable, and valid models of the supermarkets are produced, and it would require the necessary

data collection straight from the selected supermarket store. This data includes the plans with AutoCAD drawings, the annual energy consumption, energy performance certificates (EPCs), building measurements and elevations, etc. Since such data is confidential and not publicly accessible, it can be highly time-consuming. However, due to the collaborative nature of the project with LIDL GB, access to all such necessary data has been permitted. Finally, since the category of 'supermarkets' is not specifically available in the building types of modelling software being used, the closest category in TAS EDSL software, the 'offices,' is used instead.

1.1.4 Structure and Layout

1.1.4.1 Chapter 1 – Introduction to the work

The current chapter explores the scope of work. It critically reviews the main issues and background of the supermarket industry in the UK and how future climate change affects the performance of critical services. It also details the current gap in knowledge, comes up with the research questions and objectives and lays out the structure of the thesis.

1.1.4.2 Chapter 2 – Literature Review

This chapter delves into a comprehensive review of the foundational literature that shapes the research's aims and objectives. The journey begins with the genesis of the climate change concept and its implications on non-residential buildings. A meticulous examination of Europe's building stock and the accuracy of weather files follows. The chapter then presents an in-depth analysis of contemporary contributions to the study of supermarkets and non-residential buildings in the context of climate change, drawing from global academic and scientific insights. A spotlight is cast on the UK supermarket industry, its associated emissions, and the intricacies of weather files (both current and future). The chapter also elucidates representative concentration pathways (RCPs) to grasp the diverse emission scenarios and their ramifications on buildings. Key focal points include quantifying climate change's impact on energy consumption and carbon emissions of a typical UK supermarket, discerning performance variations of supermarket buildings across different UK regional climates, and understanding the influence of energy efficiency measures (EEMs) in achieving the UK's nZEB standards. The chapter culminates by discussing the chosen approach, the development of pertinent weather data files, and the selection criteria for the most fitting weather file based on the simulated building and its geographical context.

1.1.4.3 Chapter 3 – Methodology

This chapter covers the research questions of the thesis and the quantitative methodology used to answer them. Numerical data is gathered from online information and obtained directly from the supermarket supplier. This data is then analysed using mathematical formulas and their applications to produce relevant and verifiable study results. The modelling software, Thermal Analysis Simulation (TAS), developed by Environmental Design Solutions Limited (EDSL), offers tangible results that aid in examining the impact of climate change on the baseline supermarket model. It is a highly versatile tool to validate the constructed model, check for the results, and obtain essential reports such as the EPC and Building Regulation UK part L (BRUK-L) reports. It also allows us to incorporate any changes in the location of the supermarket building in the UK along with any weather files of the location and obtain results with hourly dynamic simulations. TAS also supports any changes to the building fabric and

building services, assisting in producing results with various energy-saving techniques implemented. All these different methodologies are explained in detail and step-by-step throughout this chapter.

1.1.4.4 Chapter 4 - Investigating the Potential Impact of Future Climate Change on UK Supermarket Building Performance

This chapter explores an approach to calculating and validating the typical modelled supermarket building. It gathers and presents the energy consumption and carbon emissions results using detailed figures and tables; it then analyses and discusses the main findings and ways to make the supermarket building-proof under future climate change.

1.1.4.5 Chapter 5 - A comparative study of supermarket building performance under current and future weather conditions: UK case study

This chapter investigates and compares the holistic energy consumption, carbon emissions, and cooling and heating consumption of a newly built typical supermarket spread across various regional climates in the UK using thermal simulations and under different emission scenarios.

1.1.4.6 Chapter 6 – Reaching nZEB: Impact of EEMs on a newly built supermarket in London

This chapter will use the EU Zebra2020 tool to incorporate UK nZEB building targets to assess the potential of implementing energy efficient measures (EEMs) and their contribution to reducing primary energy consumption (PEC) and total emissions. The results will show that even though newly built supermarkets are constructed with energy-saving techniques, measures can still assist in reaching nZEB, such as using microgeneration/renewable technology.

1.1.4.7 Chapter 7 – Comparative analysis of the operational vs embodied carbon of three construction methods of a UK-based supermarket

This chapter explores the complete life cycle analysis of UK-based supermarket buildings considering the embodied and operational carbon emissions under future climate change. It covers the A1-A5, B1- B7 and C1-C4 life cycle stages and, with the help of numerical data, analyses the outcome and is supported by detailed tables and figures.

1.1.4.8 Chapter 8 – Investigating the future climate impact of modern construction methods (MMCs) on the building performance of UK supermarkets: Case study Embodied carbon of operational primary building services.

This chapter will investigate various methods of construction of non-domestic buildings and their effect on the building performance of a typical UK supermarket under the worst-case scenarios of the 2080s period of climate change joining the two different sides of built environment, construction, and operation.

1.1.4.9 Chapter 9 – Conclusion.

The final chapter presents the main summary of findings and recommendations from the main 'Result and Discussion' sections. A short discussion of how the research could be continued and the associated limitations are also offered.

Chapter 2: Literature Review

2.1 Climate change and the Built environment

As a result, the impact of CO₂ emissions within the built environment is now a cause for alarm in the UK and globally, especially given that there is little time to make a positive impact. While urban development, such as multiple supermarket stores everywhere, has helped people to have a better quality of life with all the life essentials closely located, it has caused a high surge in energy usage and carbon emissions in today's world. There is growing concern among the scientific community about decreasing the current energy demand and emissions of greenhouse gases (GHG) in the supermarket building sector in Europe. GHG has incredibly detrimental environmental effects, including global warming, extreme weather conditions, and patterns contributing to the already rapidly changing global climate. There is abundant evidence to suggest that global warming is the main contributor to the increase in climatic change (De Wilde & Coley 2012). It harms the built environment as it will directly affect the cooling and heating demand of the buildings. The relationship between the built environment and climate change is complex as building development affects climate change adversely, leading to more energy usage of buildings (Jiang et al. 2019). Several investigations have been carried out worldwide, focusing on this complex relationship between climate change and the built environment. A pattern has emerged which shows the contrast between the operational (heating/cooling) demands to be more substantial as a result of climate change (Daly, Cooper & Ma 2014; Andrić, Koc & Al-Ghamdi 2019; Cabeza, Chàfer & Mata 2020) depending upon the regional and the local weather (Guan 2009).

The evolution of understanding climate change's impact on building energy consumption has been well-documented over the years. One of the pioneering works in this domain was presented by Loveland and Brown in 1989, commissioned by the United States Congress. Their comprehensive research spanned across five distinct building types situated in six US cities. Their findings were unequivocal: cooling demands would witness a substantial surge, regardless of whether the load was internal or skin-dominated (Loveland & Brown 1996). The UK's context was brought into focus by Gaterell and McEvoy in 2005, where they meticulously explored the ramifications of climate change on the energy efficiency of detached dwellings (Gaterell & McEvoy, 2005). This was further complemented by Hacker et al., who, in a series of studies published in 2005 and 2008, delved into the multifaceted impact of climate change on indoor environments, carbon dioxide emissions, and the pivotal role of thermal mass (Hacker et al. 2005 and 2008). A notable contribution to this body of knowledge was made by Lomas and Ji in 2009. Their research centred on the potential of natural ventilation in hospital wards, especially when subjected to alternative weather projections (Lomas and Ji 2009). These studies, among others, form the bedrock of our understanding of climate change's influence on buildings, particularly in the context of energy consumption, carbon emissions, and adaptive strategies.

Similarly, another study focusing on a specific building system of natural ventilation focusing on wind prediction using information from the UKCP09 was presented in 2012 (Barclays et al. 2012). Another critical climate change study was published in 2012, reporting that the degree-day method and building simulation approach were the most popular. Whether the reduction in heating demand would outweigh the increase in required cooling depended on the climate

under consideration (Li et al. 2012). A researcher from Hong Kong produced an hourly future weather file for the city and predicted a surge of up to 24% of the energy usage for cooling a building (Chan 2011). Hassan Radhi (2009) investigated the potential impact of future weather on the United Arab Emirates residential buildings to study the associated CO₂ emissions of the buildings. In 2017, a scientist calculated the future energy consumption for residential buildings in multiple cities across the USA with four different climate conditions on the North American continent. He could predict the increase and decrease in energy need through morphing techniques based on the location (Shen 2017). Wang et al. (2011) performed experiments to predict the heating and cooling energy requirements and associated carbon emissions of residential houses under future weather scenarios in Australia. Figure 1 gives a geographical view of the various research carried out throughout the globe by academics to quantify and mitigate the effect of climate change. It includes places such as Europe (Cellura et al. 2018), South Europe (Pathan et al., 2017) (Sabunas & Kanapickas 2017), Lithuania (Koči et al. 2019) (Hamdy et al. 2017), Netherlands (Dodoo & Gustavsson, 2016) (Shibuya & Croxford 2016), Northern China (Bai, Yang, & Song 2019), Hong Kong (Wan et al. 2012), Middle East (Farah et al. 2019) (Roshan, Oji, & Attia 2019) (Petri and Caldeira, 2015).

Throughout these various locations, several different methodologies are used. However, an expected outcome of the studies indicates a decrease in the heating energy demand and an increase in cooling energy demand (Oldewurtel et al. 2012).

Within this context, IPCC dictates that more than 32% of total global energy usage and 19% of the total GHG emissions are due to building processes (IPCC 2014). Another study claims energy needs in energy-intensity buildings in the most advanced countries, such as the UK. Such as supermarkets and non-residential buildings like warehouses or retail buildings concerned with winter heating, summer cooling, domestic hot water (DHW) production, lighting and household appliances (Salata et al. 2018). According to another article, from 1970 to 2010, energy-related carbon emissions on a global scale increased more than double in the building sector. They are predicted to double again by 2050 (Berardi 2017).

in



Figure 1: Various geographical locations under scientific research to investigate the effects of climate change on the energy consumption and carbon emissions of buildings (Ciancio et al. 2020).

The recent discussions over increasing pollution and GHGs have initiated a debate among the UK Government and other industry sectors to reduce its environmental impact to ensure a sustainable future.

As a result, the UK Government announced the Climate Change Act 2008, introducing a legally binding framework to cut emissions of greenhouse gasses by 80% by 2050 compared with 1990 levels as defined in Chapter 27 of the Act (CCA 2008). The increase in global CO₂ and GHG emissions levels is mainly attributed to anthropogenic activities. An industrial production system and economic development rely mainly on burning fossil fuels damaging the atmosphere and the carbon cycle. As a result, it is also important to note that several significant climate change events have occurred in the past, specifically, the UN Climate negotiations. A brief timeline of the major decisions regarding climate change can be summarised starting from 1988. The UN launched the IPCC to assess the developing science on climate change and provide up-to-date information to governments. In 1992, the Rio Earth Summit took place in which 178 countries adopted a set of principles for improving and protecting the environment. One of the more important events was the Kyoto Protocol in 1997, a pledge for industrially advanced countries to reduce emissions by an average of 5% by 2008-12. In 2006, the Paris Agreement was negotiated by 196 parties focusing on keeping the long-term temperature below 2 °C above pre-industrial levels and preferably limiting the increase to 1.5 °C. Recently, COP26 resulted in the Glasgow Pact focusing on explicitly planning to reduce unabated coal usage.

Moreover, since climate change directly affects the built environment, the industry must quantify how the change in climate impacts the buildings. It is noted that it affects the functioning of a building by reducing winter heating demand and increasing summer cooling demand. It applies primarily to supermarkets' operations as they are considered "high energy use intensity (EUI)" due to their increased refrigeration and lighting needs. A study shows that almost 33 per cent of the building's operational energy usage can be decreased if energy efficiency measures and construction methodology is modernised along with retrofitting strategies (Urge-Vorsatz et al. 2013).

2.2 Development of climate change models

As an authority on human-induced climate change, IPCC has produced multiple assessment reports over the years and their third and fourth assessment reports (AR3, AR4). In these reports, IPCC introduced the future GHG emissions scenarios A1, A2, B1 and B2 based on factors such as future global population development, technology implementation, economic growth, resource consumption, and social equity (Nakicenovic et al. 2003). The Assessment Report (AR5) published in 2014 replaced these emission scenarios with the Representative Concentration Pathways (RCPs), which were based on the concentration of greenhouse gases in the atmosphere (IPCC 2014). Similarly, according to the sixth assessment report of the Intergovernmental Panel on Climate Change (IPCC), human influence has warmed the atmosphere, ocean, and land. As a result, global warming of 1.5°C and 2°C will be exceeded during the 21st century unless deep reductions in CO₂ and other Greenhouse Gas (GHG) emissions occur in the coming decades (IPCC, 2021). Therefore, limiting human-induced global warming to a specific level would require limiting growing CO₂ emissions, reaching at least net zero CO₂ emissions, and substantially reducing other GHG emissions.

For this reason, the scientific research community has been working on developing the science of building simulations to perform calculations based on future weather data. Furthermore,

based on atmospheric-ocean general circulation models (GCM) developed by Normal A. Philips to help predict climatic variations at a relatively high level of spatial resolution (Randall et al. 2007). These statistical computer models help simulate the physical processes of the atmosphere around Earth and the oceans. However, GCMs, predict climate changes at a high spatial resolution of up to several hundred kilometres, making them unsuitable to use directly in building modelling software. Therefore, it is crucial to change, alter, or downscale it so that the converted data can be used in the built environment (Bamdad et al. 2021).

Figure 2 shows the global average surface temperature change from 2006 to 2100 under various Representative Concentration Pathways (RCPs), including a stringent mitigation scenario (RCP2.6), two intermediate scenarios (RCP4.5 and RCP6.0), and one scenario with very high GHG emissions (RCP8.5) (IPCC 2014).

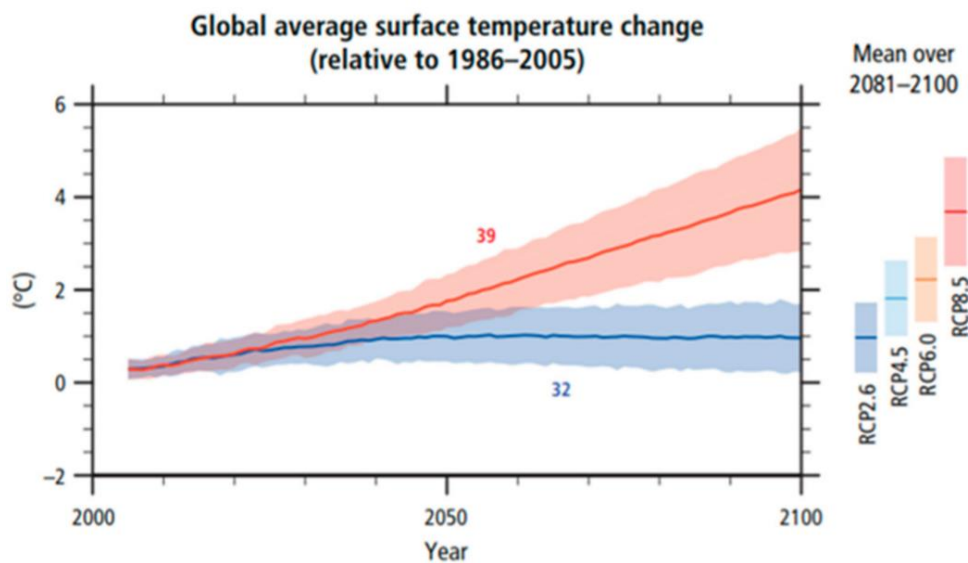

Figure 2. The global average surface temperature change from 2006 to 2100.

The future climate projections show that the mean surface temperature will rise over the coming years under all the possible emission scenarios. The heatwaves will continue to happen more often and last longer, and extreme precipitation events will become more intense and frequent in many regions (IPCC 2014). The increase of global mean surface temperature by the end of the 21st century (2081–2100) relative to 1986–2005 is likely to be 0.3°C to 1.7°C under RCP 2.6, 1.1°C to 2.6°C under RCP 4.5, 1.4°C to 3.1°C under RCP 6.0 and 2.6°C to 4.8°C under RCP 8.59 (IPCC 2018). The Arctic region will continue to warm more rapidly than the global mean (Table 1). These findings confirm the long-standing hypotheses that the climate system's warming is unequivocal and will increase summer cooling demand and reduce winter heating demand. Thus, changes in weather conditions will impact building performance (Amoako-Attah & B-Jahromi 2013).

Table 1. Projected change in global mean surface temperature (IPCC 2014).

	Scenario	2046 – 2065		2081 - 2100	
		Mean	Likely range	Mean	Likely range
Global mean surface	RCP2.6	1.0	0.4 to 1.6	1.0	0.3 to 1.7
	RCP4.5	1.4	0.9 to 2.0	1.8	1.1 to 2.6
	RCP6.0	1.3	0.8 to 1.8	2.2	1.4 to 3.1

temperature change (°C)	RCP8.5	2.0	1.4 to2.6	3.7	2.6 to 4.8
-------------------------	--------	-----	-----------	-----	------------

These essential findings prove that sensitivity to climate change is an important parameter in the functionality of buildings, especially in long-term predictions. Studies suggest that, for developed nations such as The Organisation for Economic Co-operation and Development (OECD) countries, about 25–40% of anthropogenic greenhouse emissions will be related to buildings. Moreover, 40–95% of these will be caused by operational energy use, with the rest caused by the construction and demolition of the building (Dimoudi & Tompa, 2008; Gustavsson, Joelsson, & Sathre 2010).

2.3 CO₂ emissions and Energy consumption in non-residential buildings

The carbon footprint of any building is essentially the total GHG emissions of the building in the life-cycle period. It shall cover the carbon emissions and the emissions of any other harmful GHGs. The units of GHG and the carbon footprint is ‘CO_{2-e}’, and more than often, the term ‘carbon emissions’ is misused to represent the total GHG/carbon footprint of the building (Huang, Wang & Wang 2015). Buildings have consumed immense energy and produced high GHG emissions since the late 1900s. An example is a significant surge in CO₂ emissions from fossil fuel combustion and industrial processes, contributing about 78% of the total greenhouse gas emissions from 1970 to 2011 worldwide (IPCC 2014).

According to various research studies, emissions and energy consumption in various parts of the world have been ever-increasing. For example, the building sector accounts for about 59% of the total electricity consumption in the European Union (EU) (Vittorini & Cipollone, 2016), about 20% to -30% of energy consumption in China (IEA BERC, 2015) and about 90% of national energy consumption with a 60% of carbon emissions in Hong Kong (EBHK, 2015). Similarly, the entire building stock in Australia produces about 20% of the GHG emissions of the country (Allen, 2015). The building sector in Latin America generates a quarter of the country’s total carbon emissions and 65% of total waste (ELLA 2018). The biggest country, Brazil, in South America alone, accounts for 35% of the country’s emissions (CIOB 2018). Moving towards North America, Canada's non-residential and commercial buildings were set to produce 48 Mt CO_{2-e} in 2020 (Environment Canada 2013). Similarly, Australia's commercial and office buildings comprise 60% of total energy consumption (COAG 2012). Further, South-East Asia's non-residential sector accounts for about 37% of Singapore's electricity consumption (EMA 2016) and 65% of the total electricity in Hong Kong (EBHK 2015).

Commercial buildings such as supermarkets and other retail buildings are major electricity consumers worldwide, irrespective of the geographical region. For example, the average energy use intensity (EUI) of such commercial buildings in Hong Kong was between 236 and 270 kWh/m²/year (Jing et al. 2017). For Singapore, the number is even more significant at 297 kWh/m²/year (Lam 2000). A better way to understand the comparative difference is against the residential buildings, where the EUI is significantly less than in Hong Kong. Residential buildings consume 105–147 kWh/m²/year, half that of commercial buildings (EMSD 2019).

2.3.1 Summary of the Synthesis Report of the IPCC Sixth Assessment Report (AR6) SPM and climate change data on commercial buildings

The purpose of this study is to provide an overview of the latest report of the Intergovernmental Panel on Climate Change (IPCC), with a special focus on the effect of climate change on commercial buildings, specifically supermarkets.

On 20 March 2023, the IPCC released the AR6 Synthesis Report, the last piece for the Sixth Assessment Report. The Synthesis Report serves as a summary of the current state of climate change knowledge, its global impacts and risks, as well as climate change mitigation and adaptation, integrating the main findings of the Sixth Assessment Report (AR6) based on contributions from the three Working Groups and the three Special Reports (IPCC, 2022).

The first section of the Summary for Policymakers discusses the current status and trends, with the headline statement on the observed warming and its causes in A.1, affirming that human activities, principally through emissions of greenhouse gases, have unequivocally caused global warming, with the global surface temperature reaching 1.1°C above 1850–1900 in 2011–2020. The observed changes and impacts in A.2 confirm that human-caused climate change affects every region across the globe, causing losses and damages to nature and people, and highlights the inequalities, stating that vulnerable communities who have historically contributed the least to current climate change are disproportionately affected. The Report discusses the current progress in adaptation and gaps and challenges, recognising the progress in adaptation planning and implementation across all sectors and regions with multiple benefits. However, it underlines the existing and growing gaps, as most observed adaptation responses are fragmented, incremental, sector-specific and unequally distributed across regions. Moreover, it mentions maladaptation, especially affecting marginalised and vulnerable groups adversely, insufficient financial flows, and constraints in adaptation implementation, particularly in developing countries (A.3, A.3.3, A.3.4). Among the key barriers to adaptation are limited resources, lack of private sector and citizen engagement, insufficient mobilisation of finance (including for research), low climate literacy, lack of political commitment, limited research and/or slow and low uptake of adaptation science, and low sense of urgency are listed under A.3.6.

Related to the current mitigation progress, the Report evaluates various aspects. On the one hand, it recognises the expansion of policies and laws addressing mitigation. However, it underlines that the gaps between projected emissions from implemented policies and those from nationally determined contributions (NDCs) and finance flow fall short of the levels needed to meet climate goals across all sectors and regions (A.4). Policy coverage is uneven across sectors. Without strengthening them, global warming of 3.2 [2.2–3.5]°C is projected by 2100 (A.4.4).

Renewable energy, in general, is becoming more affordable. However, the adoption of low-emission technologies lags in most developing countries, particularly least developed ones, due in part to limited finance, technology development and transfer, and capacity (A.4.5).

The second section discusses the projections for future climate change, risks, and long-term responses. The headline statement affirms that continued greenhouse gas emissions will lead

to increasing global warming, with the best estimate of reaching 1.5°C in the near term. Every increment of global warming will intensify multiple and concurrent hazards. Deep, rapid, and sustained reductions in greenhouse gas emissions would lead to a discernible slowdown in global warming within around two decades and discernible changes in atmospheric composition within a few years (B.1).

Under climate change impacts and climate-related risks, the Report projects that the likelihood of warming-charged disasters and compounding, cascading extreme events causing losses and damages increases with every increment of global warming.

Buildings play a significant role in global warming, while they are also adversely affected by climate change impacts. According to the IPCC Working Group III Report on Climate Change 2022: Mitigation of Climate Change, Buildings, global greenhouse gas (GHG) emissions from buildings were in 2019 at 12 GtCO₂-eq, equivalent to 21% of global GHG emissions that year (IPCC, 2022). Commercial buildings, especially supermarkets, are also responsible for increasing emissions.

Buildings experienced a massive increase in extreme weather damage in recent decades. They continue to face major risks of damage from the projected impacts of climate change, which can vary between and within regions. Such impacts include frequent strong winds, increased heat, particularly in cities, increased precipitation, frequent wildfires, thawing permafrost, severe storms and floods. Precipitation extremes could increase construction delays and, thus, costs. More frequent extreme weather events imply more rebuilding and repair work. Higher temperatures will reinforce changes in climate-related energy demand. The heating energy demand in developed countries is projected to stagnate until 2030, while developing countries will consume significantly more.

In my study, Hasan A. et al. (2021), we investigated the variability of future climatic conditions in a typical UK supermarket. The study highlighted the significant impact of the variability of climatic patterns on a supermarket's building performance, taking into consideration the future timelines that are also directly related to the life span of the building. It further upholds the premise that predicted that an increase in future temperatures results in an increase in energy use for cooling and emissions but conversely leads to a reduction in heating demand; likewise, an increase in cooling demand has environmental implications as it increases electricity consumption leading to higher carbon emissions related to the operational carbon emissions of the building.

Besides the current state and future projections, the IPCC Synthesis Report also stresses the potential solutions in light of the rapidly narrowing window of opportunity. Table XX recommends that GHG emissions be cut by 43% by 2030, 60% by 2035, and 84% by 2050. Rapid, cross-sectoral and far-reaching transitions are necessary to achieve deep and sustained emissions reductions and secure a liveable and sustainable future for all. Feasible, effective, and low-cost options for mitigation and adaptation are already available. In many countries, policies have enhanced energy efficiency, reduced rates of deforestation and accelerated technology deployment, leading to avoided and, in some cases, reduced or removed emissions.

Several mitigation options, notably solar energy, wind energy, electrification of urban systems, urban green infrastructure, energy efficiency, demand-side management, improved forest- and crop/grassland management, and reduced food waste and loss, are technically viable, are becoming increasingly cost-effective and are generally supported by the public (A.4.2). Accelerated climate action can also provide co-benefits, such as health benefits from improved air quality, healthy diets, active mobility (C.2.3, C.4). The economic benefits for human health from air quality improvement arising from mitigation action can be of the same order of magnitude as mitigation costs, and potentially even larger.

Urban systems are critical for achieving deep emissions reductions and advancing climate-resilient development, which includes the efficient design, construction, retrofit, and use of buildings; reducing and changing energy and material consumption; sufficiency; material substitution; and electrification in combination with low emissions sources (C.3.4). Within the buildings sector. Efficiency offers multiple benefits for both residential and commercial buildings. These include, at the construction phase, low-emission construction materials, highly efficient building envelope and the integration of renewable energy solutions; at the use phase, highly efficient appliances/equipment, the optimisation of the use of buildings and their supply with low-emission energy sources; and at the disposal phase, recycling and re-using construction materials. Sufficiency measures can limit the demand for energy and materials over the lifecycle of buildings and appliances. Early warning systems and flood-proofing of buildings have proven cost-effective in coastal flooding under the current sea level rise.

Supermarket buildings also need a shift towards efficiency, which requires better planning and design options to build a robust building design with proper equipment installation, high-efficiency heating, ventilation, and air conditioning systems, the introduction of passive design technologies to mitigate mechanical ventilation and usage of better refrigerant with low environmental impact and excellent thermodynamic performance to reduce the future energy demands in the supermarkets.

The AR6 Synthesis Report was the last major report the IPCC scheduled to release for at least the next five years. The tools and technologies are available for humanity to improve its progress in climate action and transition to a more sustainable future.

2.3.2 CO₂ Emissions and Energy Consumption in the UK supermarket industry

Only seven of nine major UK supermarkets report on the environmental performance of their buildings (Sullivan & Gouldson 2013). Additionally, minimal data are available regarding the information on sources of emissions in the building and the factors that influence the performance of building services, making it an arduous task to compare and understand the differences in performance across the retail sector or to come up with a robust standard or ranking of performance.

In a commercial building such as a supermarket, the building operations include the services such as heating, ventilation, air conditioning (HVAC) systems, lighting, domestic hot water (DHW) and other secondary/auxiliary services. All the carbon emissions produced from these services' usage are called operational carbon and are classified as 'in-use' emissions of the buildings (Fan et al., 2018). Supermarkets are responsible for between 3% and 4% of

industrialised countries' total annual energy consumption (Gullo, Hafner & Banasiak 2018). Not only that, one of the studies dictates that approximately half of the total consumed energy in a supermarket is due to the operation of the refrigeration systems, which helps maintain proper conditions for any food placed in the freezer cabinets and cold storage rooms (Minea, 2010). This point makes it extremely important that the energy consumption and the associated carbon emissions are reduced during the operational/in-usage stage of the supermarket building. Although it has been an increasing trend since the mid-2000s, retailers in the UK have started setting targets to reduce GHG emissions. Although these specific targets were built on metrics such as greenhouse gas emissions per unit of floor area, research shows that seven major UK retailers have committed to these targets in the face of inevitable climate change (Sullivan & Gouldson 2013).

IPCC 2014 report estimates that for the technical measures in a supermarket and other commercial buildings, approximately 29% of emissions can be avoided in 2020. However, following the same pattern, it could be increased to 40% in 2030 (IPCC 2014). Many European countries, including the UK, have a significant building stock responsible for massive energy consumption and results as one of the most influential areas where reduction needs to be regulated. One research discovered that the energy consumption for heat and other ends used in the UK is estimated at 79.9 Mtoe/year, up to 56.8% of the total (GOV UK, 2012). Out of the 79.9 Mtoe/year, 18.6 Mtoe/year (13.2% of the total) is used by the service sector, of which 3.33 Mtoe/year is used by the retail sector (2.3% of the total) (Kolokotroni et al. 2019). The retail sector consists of all supermarkets (large and small), and the energy usage of large food shops accounted for 31% of the retail industry, and small shops (food/non-food/convenience stores) use 41% of the retail. The energy usage and GHG emissions from any supermarket building depend on several factors, including floor area size, display products (food or non-food), energy demand for preservation and on-site preparation – hot (bakeries)/ambient/chilled/frozen. Today, even some small supermarkets (convenience stores) are classified as having high energy use intensity (EUI) as they have rapidly expanded during the last decade (Tassou et al. 2011).

Moreover, the 1% of UK GHG emissions produced by the UK supermarket sector uses lighting, heating, cold stores and on-shelf refrigeration (Sustainable Development Commission 2008). However, it has been estimated that if we consider the indirect emissions (supply chain/transport), this number is as high as 10% of the total emissions between 2000 to 2010. On average, energy intensity improvements between 2.5 to 5.5 per cent per year and over a more extended period (ten years or so), many companies have achieved annual improvements of 2 – 3 per cent (Sullivan & Gouldson 2013).

The data available for the UK indicate that a good practice regarding the annual energy consumption is between 1034-1115 kWh/m² depending on the sales floor area (SFA) and the fuels used and based on data from the 1990s. In addition, many studies showed that in the past ten years, supermarkets in the UK have significantly improved their operational efficiency.

As mentioned, the data available regarding the energy and carbon emissions of supermarkets depend directly on the size, as smaller stores have a more significant amount of energy intensity. The benchmarks mentioned by CIBSE aspire to be 505 kWh/m² for large food stores; for small food stores, the benchmark is 310 kWh/m² (CIBSE 2008). Therefore, it is one of the opposites of the trends mentioned by other studies (Tassou et al. 2011) and (Timmer, Skudritis, & Blumberga 2016). Furthermore, for smaller supermarket chains, the energy consumption

based on the gross floor area (GFA) per metre square comes to 792 kWh (DECC, 2013). As for a commercial retailer (like a supermarket) with a mean sales floor of 3306 m², the energy consumption is reported to be 759 kWh/m² (Foster et al. 2018).

An example of the energy consumption of commercial buildings can be seen by analysing the survey conducted in England and Wales in 2014-2015 by the Building Energy Efficiency Survey (BEES) and published in 2016 (BEES 2016). In this survey, the buildings were divided into ten areas, and one of the sectors was ‘retail’. Moreover, the classification of the retail sector included large food shops and small shops as sub-sectors, with floor areas being recorded as GIA (covering from the internal face of each premises’ wall) as opposed to SFA (measuring only usable floor area for sales of products). A description showing the energy intensity of large food stores is shown in Table 2.

Table 2. Energy intensity of large food stores (BEES 2016).

Energy intensity	Total (kWh/m ² .year)	Electrical (kWh/m ² .year)	Non-electrical (kWh/m ² .year)
Average	565	403	162
Minimum	400	260	115
Maximum	740	560	250

As explained earlier, one of the most common performance indicators for supermarket buildings includes size (total area/sales area), opening and closing hours of the shop, refrigeration system and equipment, installed total capacity and, significantly, local climate or geographical location. Other smaller factors also play an essential role in deciding the building's overall performance, such as the volume of sales (monetary), year of construction (dealing with building codes/regulations), management style and system control and dynamics.

A study in 2018 analysed energy consumption data from 565 supermarket stores in the UK (Foster et al. 2018). The stores included refrigerated food. Figure 3 (a-b) shows that average energy intensity tends to increase for smaller GFA and SFA. The average energy intensity for the undertaken stores was calculated to be 450 kWh/m²—per year (based on gross floor area). A detailed study of one of the stores revealed a 3.30% annual reduction in energy consumption between 2013 and 2017. Over five years, the total energy consumption reductions by 32% by lighting, 20% by refrigeration and 8% by HVAC systems

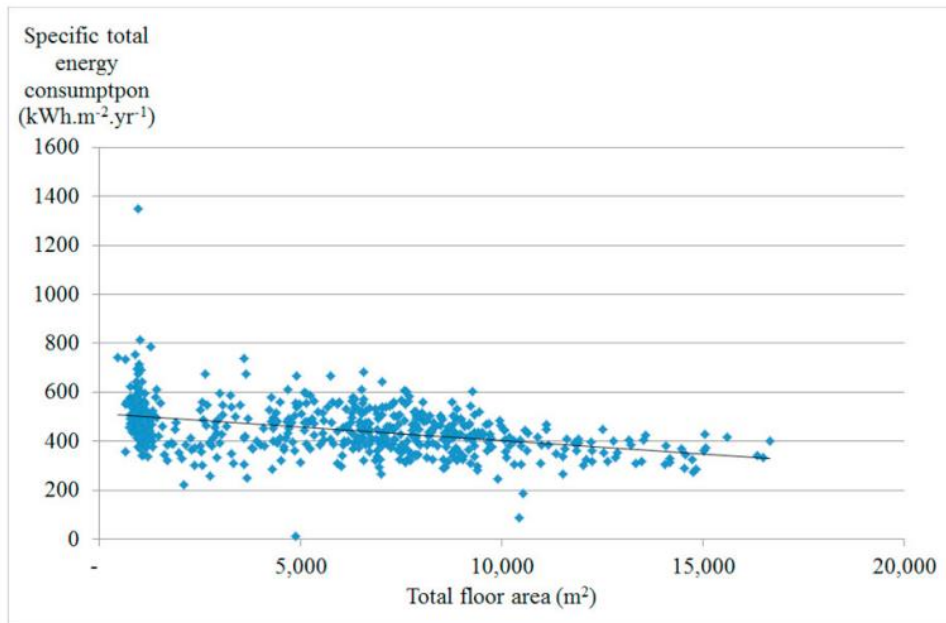

Figure 3a. Energy intensity for total floor area (Foster et al. 2018).

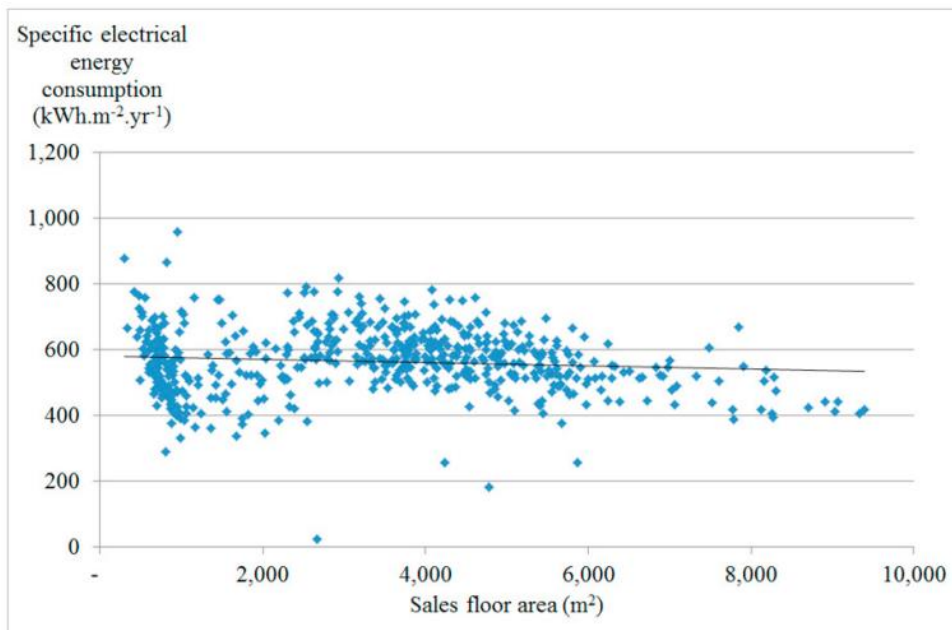

Figure 3b. Electrical energy intensity for sales floor area.

There is a possible deviation in the energy intensity of supermarket stores observed compared to the floor area. A compilation of such deviations is collected in Table 3, where the focus of the investigation is taken from Tassou et al. (2011) and Van der Sluis et al. (2015).

Table 3. Energy consumption of different retailers (Foster et al. 2018).

Source	Store location and date	Energy intensity (kWh/m ²)	Basis of electricity consumption	Floor area (FA) applicable for	Notes
Tassou et al. (2011)	UK	1700 to 1320	Electrical energy /SFA	80 to 280	Reduces with larger FA
Tassou et al. (2011)	UK	1500 to 850	Electrical energy /SFA	280 to 1400	Reduces with larger FA
Tassou et al. (2011)	UK	920	Electrical energy /SFA	1400 to 5000	Reduces with larger FA
Tassou et al. (2011)	UK	870 to 660	Electrical energy /SFA	5000 to 10000	Reduces with larger FA
Van der Sluis et al. (2015)	Netherlands (2013)	407	Electrical energy /SFA	~400 to ~1000	Reduces with larger FA
Van der Sluis et al. (2015)	Sweden (Old)	~ 500 to ~250	Total energy /GFA	~200 to ~9000	Reduces with larger FA
Van der Sluis et al. (2015)	Sweden (new)	~ 550 to ~200	Total energy /GFA	~1000 to ~14000	Reduces with larger FA
Van der Sluis et al. (2015)	USA	~ 700 to ~500	Total energy /GFA	~3000 to ~7500	Reduces with larger FA
Van der Sluis et al. (2015)	Canada	~ 1000 to ~700	Total energy /GFA	~2000 to ~1100	Reduces with larger FA

2.4 Building Modelling and Simulation

Much effort has been devoted to developing sustainability transitions (Köhler et al. 2019). Furthermore, as energy is one of the most notable parameters in building performance, much research is focused on developing modelling around it (Markard & Hoffmann 2016).

Energy efficiency focusing on reducing emissions is the new norm where enhancing the building performance is the key priority and has now become an integral part of the building design as the standards of building regulations have recently increased (CIBSE 2015). In today's world of setting efficiency goals and decarbonisation as a response to increasing global warming, building modelling tools play a vital role. These powerful computational tools help to evaluate the compliance of any building to the most recent building codes and regulations by calculating the predicted annual energy performance. These tools can also produce an annual carbon emissions report, overheating analysis, and the building's interaction with its

external and internal environment sections. It also considers the local weather/climate data and therefore comes up with the most accurate results, which can be validated against real-time buildings.

The reason for developing and improving the building modelling computational models is to provide an early insight into estimating the energy performance of the building and therefore improve the building services by different means (such as using renewable energy). Furthermore, it is used to reduce the carbon footprint of the building while the building is in use, as the bulk of the energy production comes from renewable energy sources. An important factor while modelling is the quality of input parameters because they are used to carry out the thermal model and later used to perfect the accuracy of the baseline model in terms of energy consumption and successful simulation (Calleja Rodríguez et al. 2013). Various factors accompany the accuracy of the baseline model. However, certain real-time conditions cannot be replicated, such as the number of customers in the supermarket at any given time, plug load energy consumption and natural calamities (drastic weather changes). Other factors that can affect the total energy performance of any building are poor decision-making while modelling and issues with energy management and building systems. According to ASHRAE, the following factors must be considered when performing an accurate energy analysis approach:

- Accuracy.
- Sensitivity.
- Speed.
- Reproducibility.
- Ease of use and level of detail.
- Availability of required data.
- Quality of the output.
- Stage of the project. (ASHRAE 1997)

2.4.1 Building modelling energy performance gap

Building energy modelling is an essential element of today's design process. However, research shows that buildings can use up to twice as much energy as they theoretically can (Norford et al. 1994; Pegg et al. 2007). Regulatory performance is established in the UK and most other countries by compliance modelling, which uses thermal modelling to compute a building's energy performance under defined operating conditions (set points, operation schedules). Compliance modelling is a helpful technique for assessing building energy efficiency under standardised settings to see if minimum performance standards are satisfied. However, when the results of compliance modelling are used to evaluate actual energy performance, there is a great danger that energy-related concerns may go unreported due to the gap between measured and modelled energy.

Moreover, there is an increasing concern in the building and construction industry about the mismatch between the predicted energy performance of a building and the actual measured performance. This problem is typically called the 'performance gap' (de Wilde 2014). Extensive studies suggest that the building performance in actual use differs from the model/simulation (Borgstein, Lamberts & Hensen 2016; Bordass et al. 2001). A margin of error between predicted and measured energy use is unavoidable due to design, operation uncertainties, and measurement system limitations. Explaining its magnitude and underlying causes are required to forecast and understand energy use in buildings more confidently. It is

an essential criterion of building design as it is typically higher than the modelled energy prediction, so much so that a study suggests that the magnitude of the gap is so substantial that measured energy can be as high as 2.5 times the predicted energy usage (Menezes et al. 2012).

Increasing the efficiency of the supermarket building design to meet the criteria of a high-performance building, zero carbon or nearly zero energy building, is essential to bridge the performance energy gap. Especially at the design and engineering stage, which could help meet the certification level. It is also crucial to construct buildings which would be climate change and future-proof by maintaining adequate performance throughout their lifetime and are designed to adapt to changing use conditions (Deng, Wang & Dai 2014).

Studies by the Post-occupancy Review of Buildings and their Engineering (PROBE) suggest discrepancies exist in the modelling programs because of poor assumptions and a lack of monitoring of the following construction protocols (PROBE 2022). A description of the leading causes of differences in performance gaps is provided in Table 4.

Table 4. Causes of discrepancies between predicted and actual energy performance (Menezes et al. 2012).

	Causal Factors
Predicted Performance	Design Assumptions
	Data input into a building energy model relies significantly on assumptions, which often go unchallenged. These are usually made at the design stage when many aspects of the building’s function and use are unknown or uncertain. This situation can result in oversimplified and unrealistic inputs regarding the built quality and fabric performance, occupancy patterns and behaviour, as well as the management and control of the building and its services (Tian et al. 2018)
	Modelling Tools
	Building energy modelling software can contain fundamental errors embedded in the equations used by the program, leading to inaccuracies in the predictions. This situation should be avoided by choosing modelling tools that have been appropriately validated according to the procedures defined by CIBSE TM33 (CIBSE 2006). The choice of software should also consider the building type being modelled and allow for adequate representation of the building itself and its use and operation. Restrictive or oversimplified tools can result in models that are unrepresentative of reality (Tian et al. 2018)
Actual Performance	Management and controls
	Facilities managers (FM) control central plant equipment, accounting for a significant portion of the energy consumption in a building (especially in highly automated buildings). Good management and controls can result in an efficient operation of the building services, whilst inappropriate strategies can result in unnecessary waste of energy (Bordass et al. 2001). Frequent energy audits, as well as re-commissioning exercises, can help maximise the efficiency of building services, avoiding unnecessary energy waste (Way & Bordass 2005)
	<i>Occupancy behaviour</i>

	Building occupants do not always have direct control over building services such as heating and cooling. Nevertheless, even in highly automated buildings, occupants can affect their energy consumption by influencing the internal conditions (e.g., opening windows and blocking air inlets/outlets) (Demanuele et al. 2010). Moreover, occupants have control over various energy-consuming equipment and appliances, commonly referred to as ‘unregulated loads’ (i.e., not controlled by Building Regulations)
	<i>Built quality</i>
	The in-use energy performance of a building is affected by the quality of its construction. Issues such as gaps in the insulation and thermal bridging are standard but rarely considered in the energy consumption predictions. Moreover, changing client requests and value engineering exercises can vary significantly from what was initially specified (Borgstein, Lamberts & Hensen 2016). Yet these alterations are rarely fed back into the energy model

2.4.2 Studies on performance gap and estimation of building energy performance

Several studies over the last 20 years have identified and explained a significant 'performance gap' between the designed and actual energy performance of buildings. The Centre for Interactive Research on Sustainability (CIRS) building at the University of British Columbia in Vancouver, Canada, is studied for its anticipated and achieved energy performance. Selected performance 'failures' that emerged during CIRS operation are investigated to determine how they were discovered, and the efforts required to resolve them: the energy systems and associated controls and monitoring (Fedoruk et al. 2015).

It is necessary to investigate the predicted and measured energy use to understand the underlying causes of the performance gap. Furthermore, feedback contributes to improving future design stage models by identifying common erroneous assumptions and developing best-practice modelling approaches (Raftery et al. 2011).

As a part of the UK regulatory energy performance gap study, an average gap of 34% between the predicted and actual measured energy usage was found. This research included a case study of 62 buildings having a standard deviation of 55% (van Dronkelaar et al. 2016). It was later found that the main contributors to this performance gap were building modelling (20–60%), occupants' behaviour (10–80%), and poor building operation (15–80%). It was later deduced that the primary focus should be the dynamic performance gap in commercial buildings, using calibrated dynamic models using real-world operational conditions. Moreover, comparing them against the collected data was compared to reduce any performance gap during the operation phase. It is essential to remember that the causes of energy performance gaps are interconnected and directly related. They can also be linked to various phases of the building life, including the design, construction, and operation phases (Robinson, Foxon & Taylor, 2016). As the focus of this research is the operational phase of the building, Table 5 describes the causes of energy performance gaps while the building is in use.

Table 5. Causes of energy performance gaps in the operational phase of the building (Jradi et al., 2018).

Operational Phase (Non-commercial buildings)	Lack of continuous commissioning
	The mismatch between idealised design assumptions and actual patterns
	Faulty systems and components
	Poor practice
	Lack of maintenance and service
	Occupants' behaviour and activities
	Variations in systems operation modes and changes in the use of the building
	Inappropriate building management and control strategies
	Faulty sensors and meters
	Lack of occupancy monitoring
	Lack of customers and residents' knowledge in terms of energy efficiency and building operation

As mentioned earlier, several case studies have been investigated to locate the practical implications of the energy performance gap. A study of 16 non-domestic commercial buildings was conducted during 1995-1999 and noted that the actual energy consumption exceeded the modelled numbers. It was reported that the major assumptions made in simulations were not always valid in actual cases (Bordass et al. 2001). Another report claimed that up to 80 per cent of the buildings investigated consumed more energy than predicted in modelling, including sectors like retail, education, office, and residential buildings in the UK. (Pegg, Cripps & Kolokotroni 2005).

Other European countries, such as Italy and Denmark, have experienced a similar energy performance gap which was reported to be as high as 30 per cent between the estimated and actual energy consumption (Tronchin & Fabbri 2010). Similarly, a study investigated the performance of 21 academic and research buildings in Spain to determine the difference between the actual energy consumption and the estimated consumption predicted by the official Spanish software for Energy Performance Certification of Buildings CALENER-GT. The discrepancy between these two was an average of 30 per cent. The factors were the complex graphic implementation of buildings in the tool, generic operation schedules, generic materials and installations and standard operating conditions (Herrando et al. 2016).

More evidence on the performance gap and its underlying issues can help to support feedback mechanisms and prioritise critical issues. The primary requirement for this evidence is the collection of operational performance data, which can then be fed back to design teams to ensure lessons are learned, and problems are avoided in future designs. In addition, it can assist policymakers in understanding the energy use trend and developing regulations.

Some results and recommendations from the International Energy Agency IEA publications in Annex 44 concluded that a primary performance indicator based on supermarket floor area provides a much better estimate than indicators based on refrigerated volume(s) or installed refrigeration capacity of the supermarket. Similarly, the performance indicator to best provide the first energy consumption estimates yearly total energy consumption per sales area unit is called Average Energy Intensity (AEI). Data sets from Northern and Western Europe, such as Denmark, Sweden, and the Netherlands, indicate the current value of Average Energy Intensity to be 400 kWh/m²—per year (based on gross floor area). Supermarkets involved in the study

had an average gross area of 1360 m² and 73 opening hours per week. Based on available data, adjustments are proposed for the size of the store (gross area), opening hours per week, refrigerant and refrigeration system type, year of commissioning and optimisation of control settings. It was found that management attitude, optimisation of system dynamics, coefficient of performance (COP), or Seasonal Coefficient of Performance (SCOP) values might warrant additional corrections. However, there was insufficient data within the sample to draw conclusions. Developments, especially in refrigeration systems and lighting, increase energy efficiency in new or refurbished supermarkets from 1 - 10%. Refurbishment, therefore, is an effective management decision to increase energy efficiency (Dott et al. 2013)

2.4.3 Bridging Energy Performance Gap

Although a certain level of discrepancy between the modelling and the actual measurement of the performance gap is inevitable due to numerical errors in simulation and experimental variation in any observation (Roy & Oberkamp 2011), several techniques and preventive measures have been suggested to reduce this performance gap of the buildings since the 1960s (Clarke & Irving 1988). Each technique is helpful to some extent and varies according to the needs of buildings, size and site specificity, regional weather, and actual systems operation, among other factors.

One suggested technique is to make use of smart metering. It enables the user to process and interpret the data of the building in real-time. This data is used as a direct input to report any changing aspects of the operation of the building systems and feedback on any necessary decisions to be made to control and manage the strategy and lower the performance energy gap (Kolokotsa 2016). Sub-meter measurements and system-level meters would be programmed to give in-depth information about the gap, which can be bridged using efficient machinery. Several researchers provide another overview of the different efforts to bridge the performance gap, each developing their simulation software. For example, Strachan et al. developed an open-source building performance energy modelling software called ESP-r (Strachan, Kokogiannakis & Macdonald 2008). The critical approaches used in ESP-r are analytical validation, inter-program comparison and empirical validation, primarily based on results obtained from dedicated test cells (Manz et al. 2006). Even so, these approaches have their share of criticism. One study revealed that the analytical methodology requires strong constraints and does not reflect real-world conditions.

In contrast, the inter-program comparison does not assure that any of the tools under study reflects the actual conditions. Therefore, another proposed methodology uses monitoring and data mining techniques such as sensitive sensors, radio-frequency identification tags (RFID) tags, and global positioning, which would enable an ever-increasing high-resolution map along with real-world applications and set a better and more accurate benchmark for energy performance predictions, helping lower the energy gap (Ahmed et al. 2011).

2.5 Effect of climate change on building energy performance and Emissions

The shift in weather changes can directly influence the building's behaviour and energy performance. It can lead to a fluctuation in energy consumption, and since the source of energy production is fossil fuels, it indirectly affects the overall produced greenhouse gas (GHG) emissions. One of the most typical areas affected, including energy and emissions, is the inefficiency and malfunction caused by the building services systems because of a shift in

operational conditions and overloading (Aerts & Botzen 2011). In the worst-case scenario, the environmental effects can extend to electric grid failures and even floods in coastal areas of the UK. In addition, it has been predicted that the UK is heading towards climate change, meaning the supermarkets and commercial buildings will require significantly more cooling as the temperature keeps rising. Since these are energy-intensive buildings, they will also increase carbon emissions. These projections show that it is necessary to prepare the supermarkets for the future and be climate-proof.

As each non-domestic building is designed with a specific function, it is necessary to assess the impact of climate change tailored toward the needs and requirements. Note that buildings are designed only to meet the national guidelines and criteria for overheating. Therefore, any drastic change in the temperature due to climate change will cause the supermarket building into challenging conditions as the bulk of the increase is observed in summer and cause an increase in mean annual temperature (Lomas & Porritt 2016).

Several studies have reported that building performance has been directly affected by global warming during the lifetime of the building due to a few factors, such as outdoor conditions (Revi et al. 2014), which then leads to a worsening of building energy performance (Moazami et al. 2019), as well as thermal comfort (Yang, Yan & Lam 2014) of any high-performance buildings (Picard et al. 2020).

Campagna and Fiorito published a meta-analysis study of 146 cities in a paper which involved cities from countries across the world, notably from the United States of America (with nine studies involving US cities), followed by the Hong Kong Special Administrative Region–China (8 studies). Moreover, other countries like Japan, China, and Spain accounted for six studies, respectively—five studies from the United Kingdom and four studies each from Australia, Canada, and Italy. The results from each of the studies represent three timeline periods (the 2020s, 2050s and 2080s) and that climate change leads to a progressive reduction in heating consumption, where the median value of the variation slowly drops down, ranging from 18.6% (2020) to -48.5% (2080). In contrast, a positive increase in cooling demand was observed since the values rose from 28.8% (2020) to 60.9% (2080). The overall energy consumption rises as well, from 2.6% (2020) to 12% (2080) (Campagna & Fiorito 2022).

Such a vast collection of studies signifies that those buildings, especially high-intensity energy-use ones, can be susceptible to slight climate change. Therefore, it is necessary to model/simulate the buildings and take pre-emptive actions to prepare the supermarkets for climate change and global warming.

2.6 CIBSE weather data sets (Design Summer Year (DSY)/Test Reference Year (TRY))

The weather files used in research-based climate change publications are generated using long-term measured data which apply statistical functions such as typical meteorological year 2 (TMY2). However, it is tailored for predicting the building's average energy requirements for heating, cooling, and ventilation, excluding the peak year conditions, making them impracticable for overheating assessments. CIBSE offers two different simulation weather file sets, Test Reference Year (TRY) files for HVAC planning and Design Summer Year (DSY) for overheating analysis (Belcher, Hacker & Powell 2005). Initially, CIBSE set up these weather files for three UK cities: London, Manchester, and Edinburgh; however, since 2006, these have been extended to 14 cities in the UK using improved selection algorithms (Levermore and Parkinson, 2006). CIBSE gathers the actual weather data, including the data

dry bulb temperature (°C); wet bulb temperature (°C); atmospheric pressure (hPa); global solar irradiation ($\text{W}\cdot\text{h}/\text{m}^2$); diffuse solar irradiation ($\text{W}\cdot\text{h}/\text{m}^2$); cloud cover (oktas); wind speed (knots); wind direction (degrees clockwise from North).

CIBSE TRY files: The test reference years (TRY) files produced by CIBSE differ from the example weather year method because it was impossible to select a single actual year which is sufficiently typical of the long-term average weather (Hitchin et al. 1983). TRY weather dataset is based on building an artificial year from 12 individual months of the actual weather data obtained from the meteorological (Met) office. It enables a different strategy where instead of completing a typical year, it is only necessary to find a typical complete month out of 12 months. This task is easier as the individual months may be from different years. The 12 selected months are concatenated to make a whole year (Rahman and Dewsbury, 2007). Furthermore, the 2006 TRY files are based on weather data from 1984-2004, and the 2016 TRY files are based on weather data from 1984-2013.

CIBSE DSY files: To help measure the overheating occurrences in naturally ventilated and free running (with no medical heating or cooling) buildings, the concept of Design Summer Year (DSY) was introduced in the 1900s (Levermore & Parkinson, 2006).

The design summer year is the continuous twelve-month sequence of hourly data from the 20-year data sets. It represents a median year with a reasonably warm summer. The year selected is the mid-year of the upper quartile, based on dry bulb temperatures during Apr-Sept. The DSY enables designers to simulate the expected building performance during a year with a hot, but not extreme, summer. For the 2006 DSY files, the year with the third hottest summer from 1984-2004 was selected. For the 2016 DSY weather files, the methodology was updated, and three files for each location were produced from the weather data recorded from 1984-2013:

DSY1 – A moderately warm summer.

DSY2 – A summer with a short, intense spell.

DSY3 – A summer with a more extended, less intense warm spell.

CIBSE weather data sets cover a wide variety of cities and variable factors, and depending upon the research question under investigation, the selection of the weather file will vary accordingly. Moreover, the selected weather file must be near the location under study. Therefore, the software used for the building modelling and simulation (TAS-EDSL) also recommends that the existing preselected ‘typical years’ weather files are within the 20-30 miles radius or 30- 50 kilometres of the location, making the climatic condition as accurate as possible such as solar radiation and other relevant variables.

2.7 Building Life Cycle Assessment (LCA)

Whole Building LCA: A complete building life cycle assessment (LCA) assesses the full, cradle-to-grave environmental impact of any building, as shown in Figure 5. The process involves the production and transportation of construction materials, usage/operational carbon of the building and the end-of-life phase, including material disposal. Albeit there are some operational similarities between running LCA and Whole Life Carbon Assessment, below are the reasons mentioned that these two methods should be distinct.

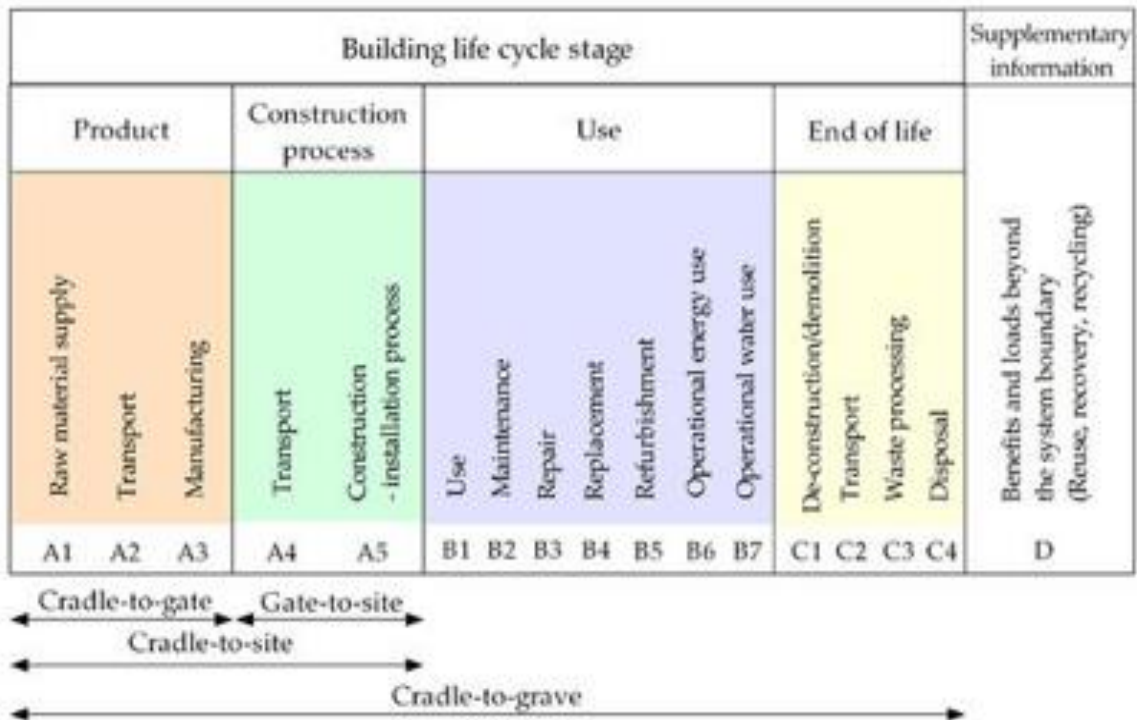

Figure 4. Building life cycle stages.

Whole life carbon assessment: It analyses the environmental impact of carbon over the building's life cycle, which comprises the embodied energy and carbon used to construct the building and then the operational/usage phase of carbon and energy. It also includes the building's end-of-life disposal (C1 – C4). Furthermore, it is usually defined over a period such as 60 years.

Life cycle assessment (LCA): LCA differs from whole life carbon assessment as it entails more than the building's embodied and operational carbon/energy. It analyses over 20 environmental indicators, including toxicity, ozone, water depletion (water footprint), eutrophication, particular matter formation, acidification, hazardous waste, material depletion, and metal depletion. Therefore, it is noteworthy that a full LCA is much more than a carbon-only assessment. In addition, an important consideration is the 'type of assessment' before starting an environmental assessment of any building. A complete LCA requires using the LCA software/tools, whereas a carbon-only assessment can be done using a spreadsheet.

2.7.1 Sustainability Assessment Certification Systems

Buildings are one of the main consumers of energy and construction materials (Schandl et al 2017). Several methods have been tested and tried to reduce the environmental and carbon footprint of these buildings, including thermal insulation (Comakli and Yuksel, 2004), material choice (Thormark 2006), passive thermal storage, better building envelope design (Sadineni, Madala & Boehm 2011), local sourcing of materials (Morel et al. 2001), and energy-efficient designs (Lin & Liu 2012). These methods have since helped the built environment to produce building regulations, standards, energy performance certificates (EPC), ratings and certifications (Yudelso 2010).

One of the early certifications created in 1990 was The British Building Research Establishment Environmental Assessment Method (BREEAM), adopted widely by the built environment community. Soon after, in 1998, US Green Building Council (USGBC) created the Leadership in Energy and Environmental Design (LEED). In addition, there were several other certifications, such as Green Standard for Energy and Environmental Design (G-SEED, Korea), the Green Star (Australia) and Comprehensive Assessment System for Built Environment Efficiency (CASBEE, Japan). However, they became less extensively adopted than BREEAM and LEED.

2.7.2 LEED Certification

American Leadership in the Energy and Environmental Design (LEED) is one of the most broadly used green building environmental assessment practices used to examine and reduce the emissions and energy from the material needs of the building (Jeong et al. 2016). LEED is essentially a point-based certification which assigns a total of 110 points, as shown in Table 6 and has several certification levels such as certified (40–49 points), silver (50–59 points), gold (60–79 points), and platinum (80 + points) as shown in the table below (Amiri et al 2021). This certification does not only have environmental benefits to it. It is also observed that having such certification increases the sale price, rent costs and occupancy premiums [10], along with the obvious benefits of saving operational energy costs and lower maintenance costs.

Table 6. Categories and points are available in the LEED system.

Category	Available Points
Sustainable Sites	26
Water efficiency	10
Energy and Atmosphere	35
Materials and Resources	14
Indoor Environmental Quality	15
Innovation in design	6
Regional Priority	4
Total	110

2.7.2.1.1 Green Building LCA credits in LEED

The credits associated with green buildings LCA show a reduction of the material life cycle impacts as compared to the baseline model of the building. It is tested in at least three different categories with a reduction of 10% without increasing the carbon emissions in three other categories by more than 5%. Additional exemplary credit can be achieved if all six categories are improved: Global warming potential (GWP), Acidification, Eutrophication, Ozone depletion, Tropospheric Ozone, and depletion of non-renewable energy sources.

The sections start broad and then funnel down to specific details as comprehensive information is provided in Table 7.

- **Rating Systems** categorise the building project.
- **Credit Categories** target systems in the building.
- **Credits** are the fundamental strategies to improve the building.
- **Points** are earned when a strategy is correctly implemented.

The more points earned, the more sustainable the building is (Everblue Training 2022).

Table 7. LCA credits in LEED

RATING SYSTEMS	CREDIT CATEGORIES	CREDITS	POINTS
New Construction	Integrative Process	Integrative Process	1
	Location & Transportation	Site Assessment	1
Existing Buildings	Sustainable Sites	Open Space	1
	Water Efficiency	Water Metering	2
Interior Design	Energy & Atmosphere	High Priority Site	1
	Material & Resources	Bicycle Facilities	1
Homes	Indoor Environmental Quality	Green Vehicles	2
	Innovation	Demand Response	1
Neighborhoods	Regional Priority	Low Emitting Materials	2
		Interior Lighting	3
		Daylight	1
		Quality Views	1

2.7.2.1.2 LEED Version 4.1

This newer version of LEED is not a total version change but an update focused on the implementation, applicability, and agility of LEED. It is developed after thoroughly consulting with construction stakeholders and the green building project teams. The rating system is much simplified with a focus on developing new methodologies for tracking and rating performance, which are then assimilated into the rating system, and in turn, into the certification. A list of updates includes:

1. The performance will be integrated and use the Arc platform's performance score.
2. Prerequisites for energy, water, indoor air quality, and basic policies (site, purchasing and smoking) will be streamlined.
3. International standards will be added or updated wherever appropriate.
4. Strategies will be linked to the performance indicators they improve.
5. The language will be added to LEED O+M (operation plus maintenance) to address interiors spaces.

2.7.1.3 LEED v4.1 Building Design and Construction (BD+C) Material and Resources (MR) Building Life-cycle Impact Reduction

A complete LCA of any building/project must be completed with up to three credits (additional one credit available for exemplary improvement) depending on impact reduction. A summary is available in Table 8 (One Click LCA® software. 2022):

Table 8. Summary of LEED v4.1 (BD+C).

Credit Option	Requirements	Credits available	Impact category requirements
LEED v4.1 MR Path 1	Complete a whole building LCA only – no requirement to demonstrate impact reduction.	1 credit	
LEED v4.1 MR Path 2	Complete a whole building LCA and demonstrate a 5% reduction in core impact categories	2 credits	Reductions must be achieved in at least 3 out of 6 impact categories, including GWP. Impacts should only increase in the remaining categories by 5%.
LEED v4.1 MR Path 3	Complete a building LCA and demonstrate a 10% reduction in core impact categories.	Three credits	Reductions must be achieved in at least three of six impact categories, including GWP. Impacts should only increase in the remaining categories by 5%.
LEED v4.1 MR Path 4	Complete a whole building LCA, demonstrate a 20% reduction of GWP and incorporate building reuse and salvage materials.	Four credits	As well as a 20% reduction for GWP, we need to demonstrate a 10% reduction in two additional impact categories.

2.7.1.4 Environmental Impacts while calculating credits

The credit calculation assessment considers all six Tools for the Reduction and Assessment of Chemical and Other Environmental Impacts (TRACI 2.1 categories) and input data consistent with local US conditions. It includes:

- **Global Warming Potential** describes how much a product contributes to climate change. When LCA concerns only this impact category, it is called the carbon footprint.
- **Acidification** describes how much product acidifies the environment, e.g., in acid rain.
- **Eutrophication** describes the flow of nutrients to ecosystems, resulting, e.g., in algae growth.
- **Ozone Depletion** describes the damage caused to the Ozone Layer in the stratosphere.
- **Tropospheric Ozone** describes the quantity of summer smog-causing gases emitted.
- **Depletion of non-renewable energy resources** describes how much fossil resources are withdrawn (One Click LCA® software 2022).

2.7.2.1 BREEAM Certification

BREEAM (Building Research Establishment's Environmental Assessment method) is one of the world's most widely used environmental assessment methods, specifically in the UK. It is considered a *de facto* measure of the environmental performance of buildings constructed in the UK. BREEAM was voluntary; however, public-funded and procured buildings must have a minimum BREEAM rating. The UK government adopted it as a 'mandatory mechanism' for all government procurement (DEFRA 2007). The rating system allows the multiple items across which the project and designing team can gain credits. Similar to the credit rating system in LEED, there are several categories, and each item is assigned a certain number of credits. Credits are grouped into energy, health and wellbeing, innovation, land use, materials, management, pollution, transport, waste, and water (BREEAM - Sustainability Assessment Method 2022). The category is further divided into various assessment issues with a set target and benchmarks. As that target or benchmark is reached, the asset score point called credits is developed as determined by the assigned BREEAM assessor. A BREEAM score is the total number of credits weighted by category. Once the building is fully developed and constructed, the final performance rating is determined by the sum of the weighted category scores (Schweber 20113). The overall performance of the building can be classified as Unclassified (<30), Pass (≥30), Good (≥45), Very Good (≥55), Excellent (≥70) and Outstanding (≥85) (Roderick et al. 2009), it is reflected in a series of stars on the BREEAM certificate. It can also be translated into the BREEAM star rating system ranging from 1-star to 5-star, with 5 being the outstanding performance, as shown in Table 9.

Table 9. BREEAM star rating system.

Number of Stars	BREEAM Rating
Unclassified	Mandatory credits not achieved.
★	≥30 - <45
★★	≥45 - <55
★★★	≥55 - <70
★★★★	≥70 - <85
★★★★★	≥85

2.7.2.2. BREEAM Version 6

This version of BREEAM In-Use (BIU) was upgraded from the older version of 2015. This new version 6 builds on the older version and supports all buildings' improvement by introducing significant improvements to (BIU) standards for commercial and residential buildings. It helps create, protect, and grow the asset value of the building over time.

2.7.2.3 BREEAM assessment criteria

The main goal is to recognise and encourage using the construction materials recognised as the 'low environmental impact' (including embodied carbon) over the entire building life cycle.

The development of the BREEAM rating system has undoubtedly helped the building community identify sustainability issues. However, since it relies on post-performance indicators, it does not inform early decision-making processes regarding the construction materials or the whole process. Therefore, to calculate the embodied carbon and energy, the Inventory of Carbon and Energy (ICE) database is usually chosen as the preferred database in the UK. It contains 200 materials and has treatment of data boundaries for products, and data has been used for embodied energy coefficients in several countries (Alwan & Jones 2014).



2.7.2.4 Credits Criteria

BREEAM awards credits based on the building has quantified environmental life cycle impact by assessing the main building elements, as shown in Table 10.

Table 10. Elements assessed by building type.

Building Type	Elements Type Assessed					
	External Walls	Windows	Roof	Upper floor slab	Internal Walls	Floor finishes/coverings
Office	✓	✓	✓	✓	×	✓
Retail	✓	✓	✓	✓	×	✓
Industrial	✓	×	✓	×	×	×
Education	✓	✓	✓	✓	✓	✓
Healthcare	✓	✓	✓	✓	✓	✓
Prisons	✓		✓	✓		✓
Courts	✓	✓	✓	✓	✓	✓
Multi-residential	✓	✓	✓	✓	✓	✓
Other buildings	✓	✓	✓	✓	✓	✓

Table 11. Overview of certification system (BREEAM vs LEED) (Pacetti 2012).

	BREEAM	LEED
Title	Building Research Establishment Environmental Assessment method	Leadership in Energy and Environment Design
Logo		
Developer	Building Research Establishment (BRE)	U.S. Green Building Council (USGBC)
Country of origin	United Kingdom	United States of America
Release	1990	1998
Groups of Criteria	Climate & Energy Resources Place Shaping Transport & Movement Community Ecology & Biodiversity Business & Economy Buildings	Smart Location & Linkage Neighbourhoods Pattern & Design Green Infrastructure & Building Innovation & Design Process Regional Priority Credits
Rating system	Outstanding Excellent Very Good Good Pass	Platinum Gold Silver Bronze
Certification phases	Planning Project Completion	Planning Construction Project Completion
Certification institute	Building Research Establishment (BRE) Global	Green Building Certification Institute (GBCI)
Assessment method	Third-party Education and Accreditation through BRE Global	Third-party Education and Accreditation through GBCI
Website	www.breeam.com	www.usgbc.org

2.7.2.5 The argument for two significant schemes (LEED vs BREEAM)

The one-size-fits-all assessment scheme is not fit for a global basis, as shown by the stark differences between the two methods provided in Table 11. Due to regions' varying

geographical and limited resourcefulness, water efficiency is an issue in countries such as Dubai and Australia but not in Scotland or Wales (Assaf &Nour, 2015). Furthermore, LEED is dominated by ASHRAE standards and its popularity in the North American continent, whereas BREEAM consists of European and UK legislation.

BREEAM has successfully adapted to the local context where the assessor can work with BRE to develop assessment criteria specific to the building where it would not fit neatly into one of the existing schemes. LEED has yet to come up with this bespoke management and adaptability level. It is designed to cater for the ASHRAE standards and the particular US standards and way of thinking as in the LEED system; credits are awarded for having enough car parking spaces, rather than minimising them as in BREEAM.

When calculating the credit, LEED calculates it differently as it is linked to the USD currency, especially the energy credits. So it creates a problem as if the market is unfavourable, the building's rating could suffer. One change that could make LEED more popular outside the US is the introduction of regional bonus credits. Six regional priority credits will be available based on what the U.S. Green Building Council's regional councils and chapters deem necessary environmentally in that region.

However, there is a disadvantage, as these credits are unavailable for non-US projects. There are potential nationalised versions of LEED, which are being developed by multiple green building councils, as Canada and India have done in the past, as well as other countries such as Brazil and Italy (Bsria.com 2022).

The assessment methods, BREEAM and LEED, have their areas, each with their niche areas or countries. However, it is observed that both have borrowed and adapted each other's ideas and tend to grow.

Based on the current observation and trend, BREEAM has a more following and adaptation in the UK simply as it is embedded in the system entirely. In addition, the UK Government requires BREEAM ratings of all their building; even the local authorities have it as a part of their planning approval for new developments over a particular area. So when the projects are developed and aimed to be zero carbon, BREEAM and LEED may have developed to become the default methods of sustainability assessment on a global scale.

2.7.3 EDGE

EDGE is another emerging certification system for green buildings used by many supermarket stores, including LIDL - GB. It stands for 'Excellence in Design for Greater Efficiencies', a program for the developing countries of the International Finance Corporation (IFC), which is a member of the World Bank Group and is financed by the Government of the United Kingdom. It was released quite recently compared to its predecessors in July 2014, and within the short time of only six years by 2020, it was being used in more than 140 countries around the globe, including countries as far as Peru.

It must be remembered that EDGE is still considered a voluntary certification and can certify buildings such as supermarkets and retail stores at any stage of the proper life cycle, which could be the stages of a conceptual idea, design, new construction, existing buildings, as well as during the renovations of residential buildings, hotels, hospitals, office buildings and educational centres. It uses free software available online applications (EDGE nd). It is a beneficial tool, and help predicts the savings of the three most important resources: Water,

Energy and Materials. Furthermore, it compares the building to a standard local baseline model, which estimates the capital costs and the return on investment (ROI). It is all made possible because the model contains a base of climate data, costs, consumption patterns and algorithms of cities to predict building services performance results.

2.7.3.1 Level of certification

As the buildings are evaluated, EDGE offers three certification levels: EDGE Certification, EDGE Advance, and EDGE Zero Carbon. Each level comes with its requirements, timing, renewal, and costs. It is suggested to use the EDGE App to reach at least 20% savings in water and materials and then choose the target for energy savings to match one of the aspiration levels.

The EDGE Certification is the easiest one to accomplish since it requires the building to maintain a minimum saving of 20% in energy operational, 20% savings in water consumption and 20% savings in embedded energy of construction materials as a minimum. Moreover, the three levels of achievement can then be obtained into two main stages. One is the preliminary certification or design stage, and the final certification or the post-construction stage.

The three levels of achievement can be obtained in two main stages: preliminary certification (design stage) and final certification (post-construction stage), as explained in Table 12 (Building and Environment 2017).

Table 12. Level of Certification (Edge Building 2022).

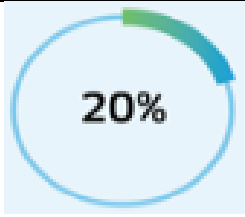
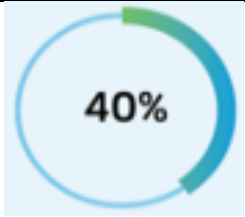
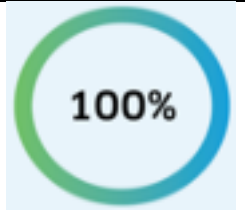
Levels:	LEVEL 1: EDGE Certified	LEVEL 2: EDGE Advanced	LEVEL 3: Zero Carbon
			
Details:	Enter the project in the EDGE App and earn a minimum of 20% savings across the three resource categories, and your project can be certified.	Set the project apart by earning EDGE Advanced, with recognition reflected on project studies, certificates, award submissions and more.	Join the global initiative for new buildings to be zero carbon by 2030 and all buildings to be zero carbon by 2050. Access our How to Apply for EDGE Zero Carbon Certification Guide for additional information.

Requirements:	20% or more energy, water, and embodied energy savings in materials.	EDGE certified with 40% or more on-site energy savings.	EDGE Advanced with 100% renewables on-site or off-site or purchased carbon offsets to top off at 100%. All energy must be accounted for, including diesel and LPG.
Timing	At the preliminary and final certification stages.	At the preliminary and final certification stages.	At least one year after final EDGE certification with 75% occupancy, when operational data must be submitted.
Renewal	Not required.	Not required.	Every four years with 100% renewables and every two years with purchased offsets.
Cost	Registration and certification fees.	Registration and certification fees.	\$500 or less at the project level and \$50 or less per housing unit for each renewal period (in addition to registration and certification fees).

2.7.3.2 EDGE Certification Guide

The steps involved in completing certification to EDGE for a project follow the pattern provided in Figure 5:



Figure 5: Guide to EDGE Certification.

2.7.3.3 EDGE incentives

EDGE provides several reasons to adopt it as the primary green energy certification. First, it brings international prestige to the project from the design stage to the operational stage. It

covers all aspects of buildings, including homebuilders, commercial owners, or buildings to sell. Table 13 explains some of the benefits of each type.

Table 13. Benefits of adopting EDGE certification.

Home Builders	Commercial Owners	Build to Sell
Attract better financing for the customers.	Increase occupancy rates	Attract investors
Label the homes as green.	Drive profitability	Distinguish the properties
Promote resource-efficient savings	Ensure cost control across properties	Complement efficiencies in construction and labour
Earn customer referrals	Take a portfolio approach with EDGE or mix and match with LEED	Accelerate turnover and quantify a sustainable brand

Furthermore, several other reasons for selecting EDGE certification are presented in Figure 6.

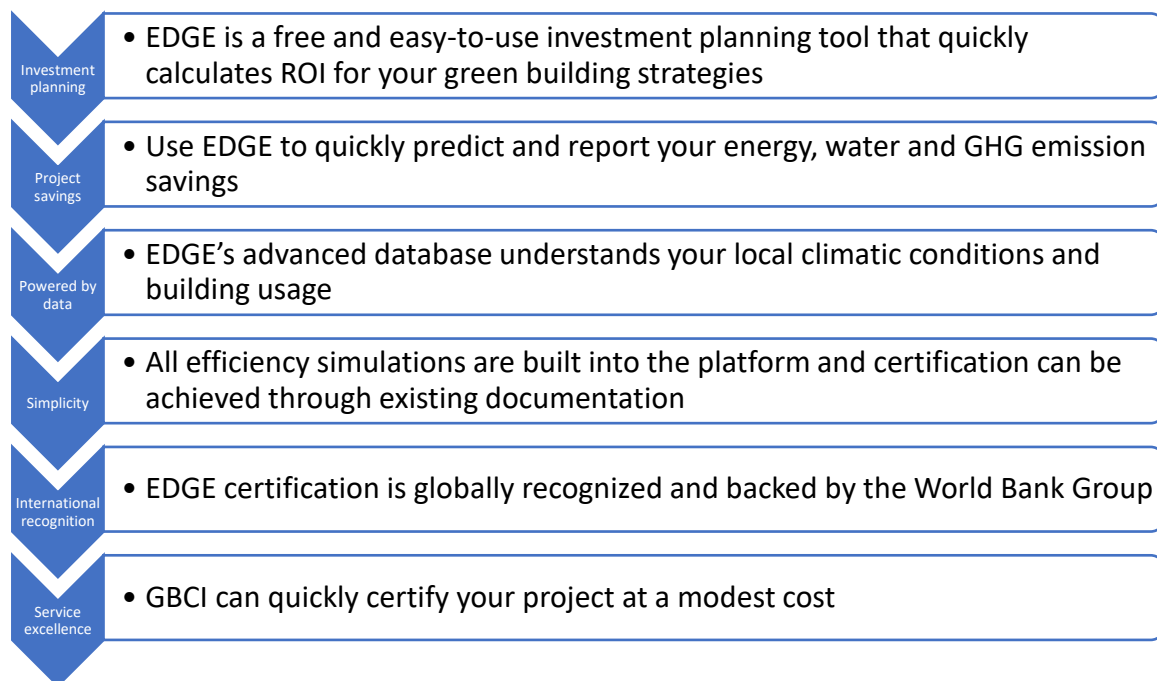

Figure 6: EDGE certification incentives.

2.7.3.4 EDGE 3.0 Version (BETA)

The new version of 3.0 (beta) has been announced using EDGE certification. In addition, it will enable the users to evaluate many other vital factors in eight categories, including the Water category, as opposed to its earlier version, 2.1. It would take the number of new categories up to 14 indicators; however, it is still undecided how many of these categories

would be mandatory to declare as the new reference guide 3.0 has not yet been published. Some new indicators in the new version 3.0 include low-consumption bidet evaluation, use of low-consumption dishwashers, kitchen rinse spray valves, energy-efficient washing machines, pool covers, efficient garden irrigation systems, and water recovery condensed and smart meters.

Finally, the savings from using the EDGE certification have become a growing trend for buildings worldwide. According to the official website of EDGE, it has saved a great deal of energy, carbon, and floor spacing, as explained in the table below.

Table 14. Total savings using EDGE certification so far.

Savings	Value
Energy Savings	1,371,250 MWh/year (megawatt/year)
Water Savings	56,420,694 m ³ /year
Embodied Energy in Material Savings	73,722,305 GJ (Gigajoules)
CO ₂ Savings	651,664 tCO ₂ /year (total carbon dioxide/year)
Floor Space Certified	35,982,561 m ²

CHAPTER 3: Methodology

3.1 Research Paradigm

A methodology is designed to produce empirical results using a distinct technique, procedure and system of a model following a research strategy or paradigm. It allows scientists and researchers to shed light on what is being investigated and to understand the issues at stake. A comprehensive book on research paradigm defines it as “the term methodology generally is used to describe several aspects of a study: the design, the procedures for data collection, methods for data analysis, selection of subjects, and details of the specific treatments” (Willis, Jost & Nilakan 2009).

Not so rare in the history of computational studies, this research will adhere to the comparative quantitative research method as it delivers the criterion of an analytical, pragmatic, and empirical inference to employ, collect and analyse data. The mentioned approach for this work is the direct outcome of changing attitudes about what constitutes the most efficient and trustworthy research technique.

Researchers typically need help in developing a feasible research project. On the one hand, they are unfamiliar with the methodological underpinnings of the major paradigms used in educational research: quantitative, qualitative, or blended, and, on the other hand, those who do not associate the corresponding research types with these paradigms: experimental, non-experimental for the former, and interactive or non-interactive for the latter. These paradigms govern the conceptualisation of the research problem, the accompanying research questions, and, more crucially, the sampling strategy and the selection of appropriate research methods.

This selection is paramount for researchers to clarify because it determines the research methodology used, the selection of appropriate research methods, and the procedure used for data analysis. Research is the systematic and organised accumulation of knowledge. However, the channels that lead to this discovery differ depending on the researcher’s method. Consequently, the research paradigms that dictate the present research procedures can only be adequately comprehended by fully comprehending their epistemological concerns.

This will mention how, among all these transformations of research methods and methodologies, this specific one will complement this research framework in scientific thought and how they led to fundamental shifts in research paradigms. Then, the section will illustrate how this affects research procedures and methodology. It should be noted that the term "method" refers to the research tools used to collect and analyse data, such as a checklist, data analysis software, and so on,

The following section will show how this research framework will fit into the research paradigm.

3.1.1 Research Design

Undoubtedly, the research question derives the research and leads the researcher to a practical solution. However, significant structure to the same research method is necessary to articulate and structure the essentials of the problem to be investigated. For the same reason, a research

design is fundamental to emphasise the research's goal and ambition. The journey started with gaining knowledge in the literature review, takes its shape and form through research design and prepares the research attributes to reach for constructive, empirical solutions. It defines the possible and most precise result for the researchers.

The research design of this work is solidly grounded on the findings of the impact of current and future climate changes on the building performance of non-residential buildings in the UK. Such as supermarkets, retail, commercial and office buildings; it depends on the factors that regional weather plays a significant part in determining the building performance outcome. Each location also has weather conditions, aiming for the highest annual energy consumption and reduction of greenhouse emissions.

Case studies of multiple locations of typical UK supermarket buildings have been incorporated into the research to establish the paradigms of research designs to increase the energy efficiency of the buildings. The juxtaposition of these cities is based on their building performances against their respective climatic conditions.

After extensive research into the local climates, the cities in the UK were selected for consideration. They chose cities with various climates to obtain a more accurate picture of the changing ecosystem. The regional climate data are utilised to construct CIBSE's "present" and "future" weather files, which are available to customers. A few cities, which have been carefully selected, offer a one-of-a-kind glimpse into the future and the direct impact of climate change. This is made possible by the wide variety of climatic variances among them. In addition, this window demonstrates how rapidly, and significantly crucial performance metrics might move due to the change.

The present and forecast weather files based on UKCP09 that CIBSE gave were utilised to execute a series of simulations using the building modelling software Thermal Analysis Software, TAS. In addition, hourly dynamic simulations of the building were run on every site. TAS EDSL was selected as the platform to employ for the simulation since it can produce dynamic models and making use of weather information. It uses separate computations, data exporting capabilities, and other software programs operating in the background (Crawley et al. 2008). In addition, it helps integrate the dynamic thermal modelling of the building with control features over natural and mixed-mode ventilation (Bahadori-Jahromi et al., 2017). After extensive investigation and consideration of the UK's regional climates, the cities in different regional climates to provide a realistic comparison image of the changing environment were selected in the same way the software was selected.

CIBSE has been an essential organisation in the field of climate change, so much so that they have been producing the weather databases used by researchers to predict and quantify global warming and its direct impact on buildings (domestic/non-domestic). The most recent weather files produced by CIBSE were divided into two main divisions – Test Reference Year (TRY) and Design Summer Year (DSY). Each plays a vital role in building services, such as TRY files assisting in energy assessments, whereas DSY files focus on the overheating analysis of the building. In addition, these weather files can be used in the simulation software packages such as TAS-EDSL and other similar building modelling software (CIBSE, 2002).

In the methodology, a critical decision was the selection of appropriate weather data for our simulations and analyses. We opted for the CIBSE's TRY (Test Reference Year) weather data for several reasons:

1. **Relevance and Representativeness:** TRY provides a statistically 'average' year in terms of weather, which is essential for assessing typical building performance over a year. On the other hand, DSY represents a particularly hot summer, which is crucial for evaluating the building's resilience and performance under extreme conditions, especially in the context of climate change.
2. **Industry Standard:** CIBSE's weather data is widely recognized and adopted in the building services industry. Using this data ensures our research aligns with industry standards and practices, making our findings more applicable and relevant to practitioners.
3. **Comprehensive Data:** TRY offer detailed hourly data, which allows for a granular analysis of building performance under various conditions.
4. **Futureproofing:** With the increasing focus on climate change and its potential impacts, using TRY ensures we consider extreme weather scenarios, preparing buildings for future challenges.

Incorporating TRY files allows for a balanced approach – evaluating buildings under 'average' conditions and preparing them for potential extremes.

3.1.2 Ethical Considerations

This research did not use human participants for data gatherings, such as interviews or questionnaires, as demonstrated by the methodological approach. As a result, the study could not break ethical principles such as participant informed consent, invasion of privacy, or deception. However, good honesty in collecting, interpreting, and analysing research data was ensured by sharing the results with other researchers via publications; plagiarism was avoided by providing adequate sources and citations in proper places. Furthermore, all data obtained and utilised for this study is secured by the Data Protection Act 1998, which states that data must be used lawfully for the purpose specified, relevantly used without excess, kept safe and secure, and not transferred without authorisation.

In this research, we have undertaken multiple case studies to provide a comprehensive understanding of the impact of climate change on supermarket buildings. The case studies were selected based on their geographical location, size, and energy consumption patterns. They include:

1. **Supermarket A in London:** A large-scale supermarket with a high footfall, representing urban energy consumption patterns.
2. **Supermarket B in Manchester:** A medium-sized supermarket, showcasing the energy needs of supermarkets in colder regions.
3. **Supermarket C in Southampton:** A small-scale supermarket in a coastal region, providing insights into the impact of humidity and temperature fluctuations.

Each case study involved a detailed analysis of the building's energy consumption, carbon emissions, and adaptation strategies to climate change.

In the methodology, we've incorporated multiple case studies, including supermarkets from diverse geographical locations like London, Manchester, and Southampton, to ensure a comprehensive understanding of climate change's impact. Our research methodology, a mixed-method approach, was chosen for its ability to provide a holistic view by combining both qualitative insights and quantitative trends. This approach not only captures the depth and breadth of the issue but also allows for cross-validation, ensuring the robustness of our findings. Data collection was a blend of primary methods, such as direct measurements and surveys, and secondary methods like literature reviews. This combination was pivotal in ensuring accuracy, offering historical context, and capturing a diverse set of data points. We believe this methodology, with its adaptability and thoroughness, aligns perfectly with the research objectives and addresses the concerns raised.

3.1.3 Building simulation software and Modelling

An essential factor in the methodology is the selection and use of the simulation and modelling software. The growing complexity of the supermarkets and built environment has given rise to several software and simulation packages with a focus on the design that has made the energy performance of the buildings an integral part of the planning process for building researchers and service engineers. As explained earlier, the software chosen for estimating annual energy consumption and carbon emission is 'TAS-EDSL'. It is used throughout to answer the multiple research questions, and it is chosen carefully after comparing it with other similar building modelling and simulation software packages. Some examples of the most used programs by engineering consultants in the UK DesignBuilder (2020), Hevacomp (2020), and IES Virtual Environment (2020).

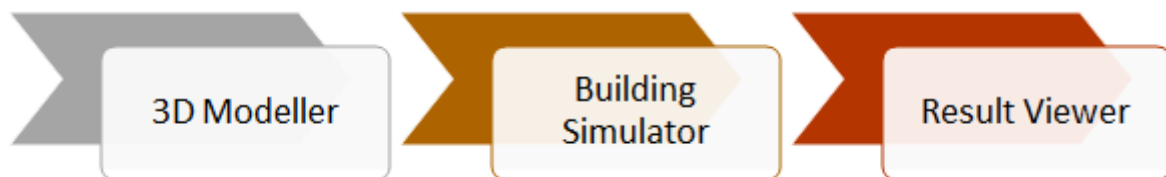

Figure 7: Process of TAS EDSL with stages.

The TAS-EDSL software has been in use for years used to carry out energy simulation investigations with publication in numerous countries such as Saudi Arabia (Alwetaishi 2019), Singapore (Priyadarsini, Hien &Wai David 2008), Austria (Berger et al. 2016), Italy (Resuli & Dervishi 2015), Chile (Pino, et al 2012), Poland (Dudkiewicz & Fidorów-Kaprawy 2017) and United Kingdom (Kang &Strand, 2019). The methodology used in TAS, and similar software follows a similar pattern with AutoCAD files to draw the walls, floors, roofs, windows, and other essential building parameters. Some other features included in these packages include daylight factor, solar heat gain, indoor air temperature and the relationship between energy consumption and daylight performance, highlighting the optimum shade type. To summarise, the process of TAS designing can be grouped into three stages. The first stage includes the outside parameter or shape of the building, the choice of location, and the elevations of the windows and door, including the introduction of waypoints. The second stage would include describing any thermal maps for the site-specific location and the materials used in building construction. It also provides a choice of the number of days required to run the thermal distribution and enter each element issued such temperature. The final stage gives the results,

which explain the number of curves representing the energy levels inside and outside the simulated building, as shown in Figure 4 (Alwetaishi, Kamel & Al-Bustami 2019).

3.1.4 TAS building simulation software.

TAS software version 9.3.3 was employed as the dynamic simulation software to model and calculate the energy performance for this study. The TAS software, designed by Engineering Development Solutions Limited (EDSL), is a set of application products capable of simulating the thermal performance of buildings and their systems, which can be translated to energy consumption estimates (Crawley et al. 2008). EDSL (2015a) highlighted that the software is approved and fully accredited for the UK building regulation 2013 and demonstrates compliance with various BS EN ISO standards. Its aptness as software for building performance estimation and energy use prediction has also been appraised via the Building Energy and Environmental Modelling (BEEM) checklist. Furthermore, it complies with the American Society of Heating, the Refrigerating and Air Conditioning Engineers (ASHRAE), building envelope and the HVAC equipment performance test (EDSL 2015a). The software has a 3-D graphic-based geometry input interface (3D Modeller) that includes a computer-aided diagram (CAD) link and can also perform daylighting calculations (Crawley et al. 2008; EDSL 2015b).

The TAS Building Designer (TBD) core module performs a dynamic building simulation with integrated natural and forced airflow (Crawley et al., 2008). Furthermore, it provides a comprehensive solution as a robust simulation and 3D modelling tool and realistically accounts for occupied summer hours underpinned by the CIBSE TM52 adaptive overheating criteria (Amoako-Attah & B-Jahromi, 2014). TAS systems are the component of the software suite which provides plant modelling capabilities to simulate systems such as heat ventilation and air conditioning (HVAC) systems/control. Another part of the TAS software suite is the TAS Ambient, a solid and easy-to-use 2D CFD package capable of producing a cross-section of microclimate variation (Crawley et al., 2008). Although numerous building software has similar capabilities, TAS software was selected because it is fully accredited in the UK for compliance with building regulations Part L2, building performance estimation and energy use prediction. TAS 3-D modelling input interface is also more intuitive than some equally consequential and popular simulation software types like EnergyPlus, which has a text file input and output interface. Moreover, it has been used commercially in the UK and worldwide for over 20 years with a reputation for its robustness, reliability, and wide-ranging capabilities. The software was also selected as it was developed in the UK, and its developer is domiciled in the UK, which ensures access to better support and training opportunities.

3.1.5 TAS Building Simulation Principle

The TAS building simulator monitors the environmental performance of the building via thermal analysis, ventilation analysis, energy consumption estimation, plant size, and energy conservation strategies. The building test method incorporates the building geometry and complete design information for anticipated interior, picks up, ventilation and invasion rates, shading highlights, occupant characteristics, gaps, warming and cooling set-points, and building texture. EDSL (2015b) describes a method for facilitating active leisure on TAS. The computer software generally evaluates the building's warm state over a year through hourly representations. This provides a detailed representation of the warm execution of the building beneath the specified design condition. The method also allows for evaluating the effects of

the warm forms operating within the structure, considering their time, interaction, and location. The investigation preparation of the software is founded on the building's warm transmission process - 89 movements of numerous heat forms transferred all over the building envelope through various heat transfer mechanisms, e.g., convection, solar radiation, and conduction. The product strategy for treating the intensity move processes in systems uses the ASHRAE Response Factor approach for dynamic analysis of conduction in the structural texture. This computerised approach evaluates conduction as chronicles at building surfaces of building components (such as separators or floors).

Furthermore, the product allows a structural texture with several layers to be broken down, and each layer can be formed of various materials such as dark (like wood), clear (like glass), or gas (like air). Convection at building surfaces is processed using a combination of hypothetical and accurate connections between partner convective intensity streams, surface temperature contrast and direction, and wind speed in outer convection. Stefan-law and Boltzmann's support of radiation by the computation of long-wave radiation trade states that the total generated heat energy from a surface equals the fourth force of its absolute temperature.

Meteorological data is required to determine the amount of solar radiation received, reflected, and transmitted by the building's various components. The algorithm uses information about the sun's location and empirical sky radiation models to determine the incidence fluxes, broken down into direct and diffuse components. Absorption, reflection, and transmission are calculated using the building's thermo-physical parameters. Transparent building materials allow solar radiation to enter the structure but can be absorbed, reflected, or transmitted depending on where it hits inside surfaces. All the sun radiation is dispersed, including that which is reflected and transmitted. Thermal insulation, thermal mass, climate, glass features, building fabric, solar gains, and plant scheduling all affect the thermal behaviour of structures in the TAS building simulator. It also shows how these parameters affect air temperature, radiant temperature, resulting temperature, humidity, energy usage, and other variables. Sections of the dynamic simulation software TAS explain the techniques used to construct holistic building models for energy estimation and assessment of improvement initiatives.

3.1.6 EDSL TAS 3D Modelling Process

Using the TAS 3D modeller component of the programme, one can input data concerning the building's geometry and material, such as the number of storeys, the types of walls, the types of windows, and the measurements of the doors. Additionally, the flooring sections were partitioned into several zones according to the activities planned for each area. All this information was combined to develop a three-dimensional model that was as accurate to the real world as feasible. The AutoCAD drawings, which display floor plans for individual rooms, served as the data source for the 3D modelling. In addition, the AutoCAD drawings were utilised to measure things at the standard height of the floor. Finally, excess layers were removed from the original AutoCAD file, and a 10-meter reference construction line was drawn as a guideline.

Following that, every stage was saved with a separate file. The blueprints also demonstrate how the many floors of the structure were subdivided into various zones, such as separate rooms, reception areas, office spaces, and toilets (WC), utilised throughout various stages of the simulation process. The zoning technique was carried out entirely based on the expected

use of the space, as the intended use has a tangible impact on the interior condition of the space, which is divided according to the use of space.

3.1.7 Thermal Simulation Process

The thermal simulation of the building is the primary function of the programme's TAS -TBD (building design) component, which serves as the central component of the software package. Therefore, to simulate the performance of a building, it is necessary to pick the most appropriate modelling parameters and assumptions. The following is a list of the modelling parameters and assumptions that were used to perform the building performance simulation in this study:

- A. The extent to which the weather data from CIBSE TRY files, derived from an analysis of previous data patterns that have been averaged over a given number of years, is appropriate to the weather conditions currently experienced at the site of the case study building.
- B. Acceptability of the Nationwide Calculation Methodology's (NCM) standard interior characteristics activities and occupancy as the supermarket structure's pre-existing circumstances was the case study's subject.
- C. The assumption that U-values are static rather than dynamic, even though they generally alter with changes in the thermal and climatic environment.

Chapter 4: Investigating the Potential Impact of Future Climate Change on UK Supermarket Building Performance – Case Study

4.1 Problem statement

The building construction sector produces almost 30% of CO₂ emissions in the operational phase, and at least 60% of these emissions are due to the use of the building during its lifetime, which shows the importance of the built environment in global warming and climate change (Palme et al. 2013). In addition, the UK building sector accounts for approximately 3% of total electricity use, and UK supermarkets and similar organisations are responsible for 1% of the total UK GHG emissions (Tassou et al. 2011).

For the UK-based buildings, the most up-to-date and accurate climate projections are provided by UK Climate Projections (UKCP), which is a climate analysis tool and forms part of the Met Office Hadley Centre Climate Programme (UKCP 2020). It assists in quantifying the direct effect of climate change on buildings by using future climatic projections.

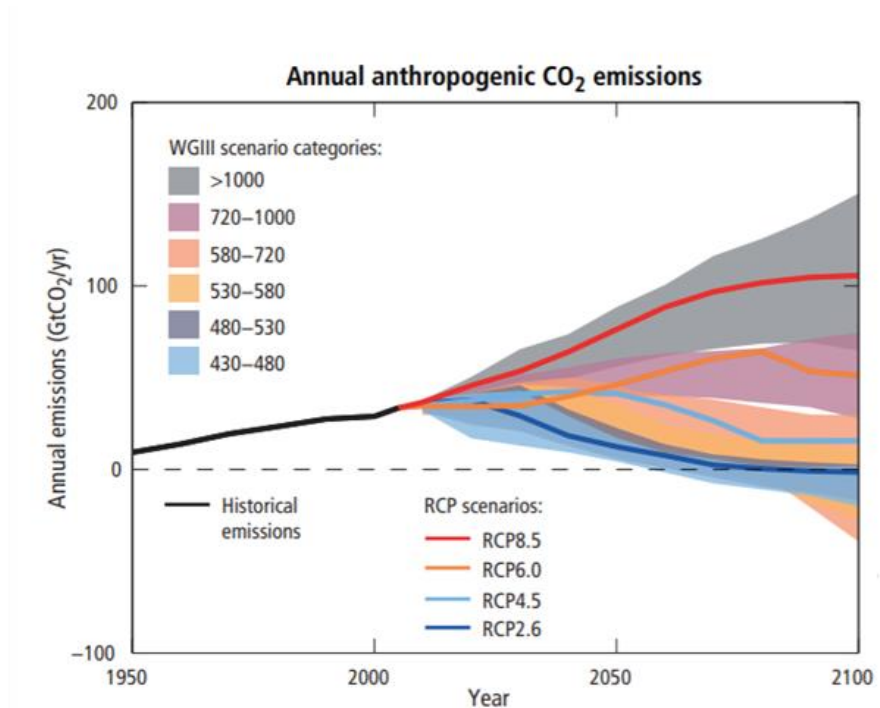

Figure 8: Annual carbon dioxide (CO₂) emissions in the representative concentration pathways (RCPs) and the associated scenario categories.

These projections are available in three emission scenarios, including high, medium, and low, for both Test Reference Years (TRY) and Design Summer Years (DSY) (Harris et al., 2013).

- A. TRY: It comprises 12 separate months of data, each chosen to be the most average month from the collected data. The TRY is used for energy analysis and compliance with the UK Building Regulations (Part L).
- B. DSY: The DSY is a single continuous year rather than a composite one from average months. The DSY is used for overheating analysis.

Figure 8 shows annual CO₂ emissions for all the scenarios and the various RCPs, which are the greenhouse gas concentration pathways.

Despite all these materials and studies available, there is still limited data regarding the impact of future climatic conditions on the operational carbon emissions of the supermarket industry. Much work has been done around other building types, and almost all the studies mentioned above were published before UKCP 2009. UKCP09 builds up the success of its predecessors and uses state-of-the-art climatic science providing a detailed future weather projection out to 2100 in the UK and globally. Based on these climatic projections, the resilience of buildings can be increased to higher temperatures, and the building's energy use can be assessed under future weather conditions.

The (CIBSE) future weather files are available for building performance analysis for 14 UK locations, including different sites for London (Weather Centre (LWC); Gatwick (GTW)) for three time periods, the 2020s (2011–2040), the 2050s (2041–2070), and the 2080s (2071–2100). These weather files have been produced to assist academics and researchers in using weather and climate change information in building design and futureproofing of buildings. The data available are presented as TRY and DSY based on UKCP09 climate change scenarios. In addition, they have low, medium, and high carbon emission scenarios with varying probabilities of 10th, 50th, and 90th percentiles (Virk et al. 2015). The current TRY and DSY were morphed to incorporate the UKCP09 climate change scenarios of the periods and the emission scenarios, helping to limit any uncertainties which could affect the baseline weather data (Eames, Kershaw, & Coley, 2010).

The building simulation and environmental performance software packages have been used (and are under constant development) for many decades. They can evaluate various external stimuli responses (Clarke 2001). Integrated modelling is defined as the best practice approach to building design as it allows the designers, architects, and engineers to link energy, the environment, and health by assessing the building's design, such as overheating analysis, assessment of building internal conditions (infiltration, ventilation, lightning gain, occupancy sensible and latent, equipment sensible and latent, and pollution generation), evaluation and enhancement of building thermal mass and evaluating alternate technologies (energy efficiency and renewable energy), and regulatory compliance and performance views (CIBSE 1998; Crawley 2006)

This study uses a government-approved and validated thermal analysis building software package (TAS EDSL) to perform a series of simulations to quantify and predict the impact of changing future weather and climatic conditions on a newly built baseline supermarket model in the UK. This investigation will evaluate five critical building performances: total annual energy consumption, annual building carbon emissions, annual electricity grid consumption, and cooling and heating demand based on the current and future CIBSE weather data set from the UK Climate Projection 2009 weather information.

4.2 Thermal Analysis Simulation (TAS-EDSL) 3D Modelling

The TAS modelling contains AutoCAD architectural building drawings of the baseline supermarket store. The drawings consist of front, rear, and gable elevations. It also has the floor and roof plans to make it as accurate as possible. Figures 9a–9d show the architectural drawings and their respective specifications.

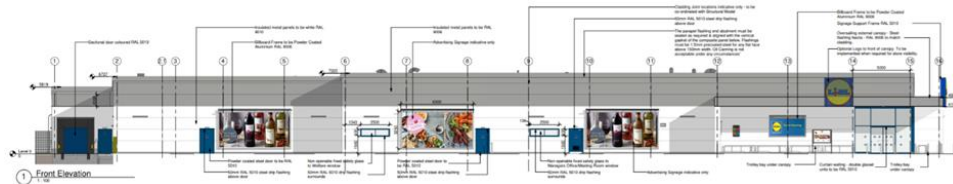

Figure 9a.

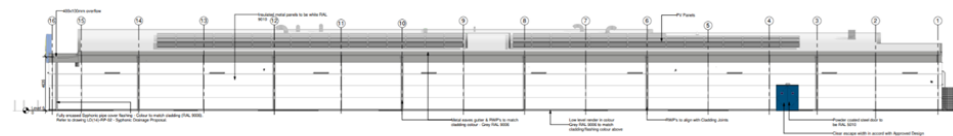

Figure 9b.

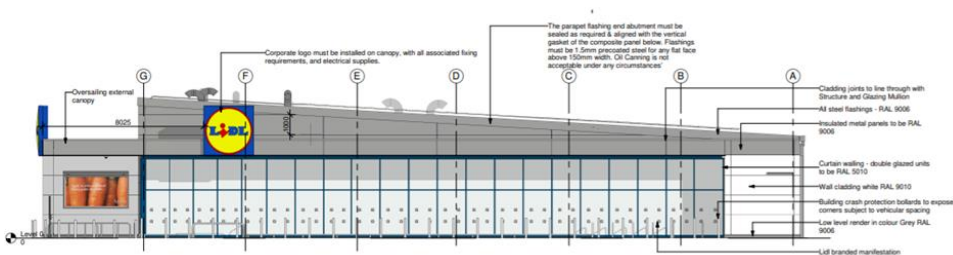

Figure 9c.

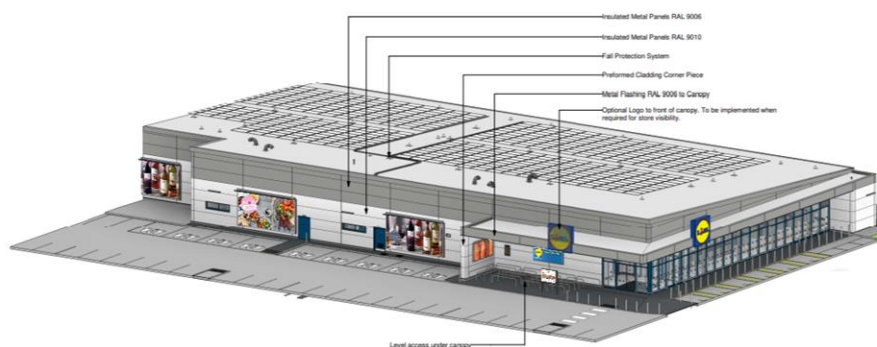

Figure 9d.

Figure 9:(a-d). Typical 3-D model building geometry (TAS-EDSL).

4.3 Modelling Process

The general arrangement architectural building drawings provide the exact measurements for the building height, sales area floor size, entrance lobby, bakery, warehouse, toilets, and other offices, including IT room, cash room, utility, meeting room, cloakroom, and welfare canteen. The total floor area of the building is around 2,500 m². The National Calculation Methodology (NCM) standard calendar reflects the supermarket's operational hours. Construction materials are assigned individually to all the building elements of the store according to the supermarket specifications, and internal conditions are applied to the individual zones. When designing the model building, certain precautions were taken to eliminate miscalculations. For example, the floor level was measured from the ground floor at 0.0 metres, and the wall heights were measured from the floor level to directly below the finishing of the roof above.

Furthermore, the floor area of the supermarket was divided into zones such as the entrance lobby, store, sales area, warehouse, bakery, welfare canteen, cloakrooms, staff toilets (male and female), corridor, meeting room, utility, cash room, IT room, and customer WC. So that they can be assigned their respective internal conditions adhering to the national calculation method. As for the weathering profile, London TRY files will be used as the store based in London, making them the closest/most appropriate weather files (Salem et al. 2019). In addition, these TRY files are used for predicting average energy consumption and compliance with UK building regulations (Eames, Ramallo-Gonzalez & Wood 2015).

4.4 Simulation Process

For the simulation process, the TAS modeller designs the thermal mass of a building and requires multiple performance parameters and assumptions to simulate the building without any errors and warnings. The simulation parameters include building summary, calendar, weather, building elements, zones, internal conditions, and schedule to simulate the building.

Table 15. Simulation assumptions: building fabric specification.

Building element	Calculated area-weighted average U-values (W/m ² K)
Wall	0.24
Floor	0.21
Roof	0.13
Windows	3.08
Personnel doors	1.32
Vehicle access doors	1.78
High-usage entrance doors	3.34

Table 16. Simulation assumptions: building summary specification.

Calendar	NCM standard
Air permeability	4.0 m ³ /h.m ² @ 50Pa
Infiltration	0.125 (ACH)
Fuel source	Grid supplied electricity
CO ₂ factor	0.519 kg/kWh

4.5 UK Building Regulation Studio 2013

TAS EDSL v 9.5.0 was fully equipped with a UK building regulation studio in 2013. It helps calculate BRUKL and Energy Performance Certificate (EPC) documents clearly and concisely using the NCM for Energy Performance of Building Directive (DCLG). It generates compliance reports suggesting whether the building adheres to the part L2 building regulations. Dynamic modelling provides a detailed and comprehensive evaluation of the building with results that can be generated hourly. It allows comparing information between the model building with a notional building to identify the potential compliance issues with the building design. Moreover, the studio generates valuable reports that include total annual energy consumption, annual electricity grid consumption, building emissions rate, and cooling/heating demand for this study (EDSL 2020).

In the baseline model, lighting control with specific auto presence detection, power efficacy and design room illuminance (lux) is applied to all the individual zones according to the typical specifications to reflect the actual store conditions. In addition, the model is also equipped with several air-sided configuration systems in place, such as a natural vent, sales area HVAC (heating, ventilation, and air conditioning), welfare MVHR (Mechanical Ventilation with Heat Recovery), welfare MVHR with AC (Mechanical Ventilation with Heat Recovery with air condition), AC only (air conditioning), extract only, and storage MVHR with AC to supply the zones. Another part of the model is the design of heating and cooling configuration circuits with modifiable efficiency and fuel sources to serve all the required components. Lastly, the model has DHW (domestic hot water) circuit configuration to provide hot water to the required areas in the store, such as the toilets and the welfare canteen.

4.6 Future Weather Data Simulation Process

The simulation covers the scenarios based on the current and future climate variables with different carbon emission scenarios (high, medium, and low) for the periods the 2050s (2041–2070) and 2080s (2071–2100).

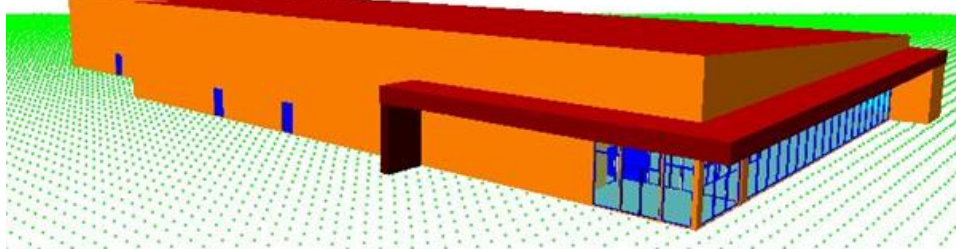

Figure 10a.

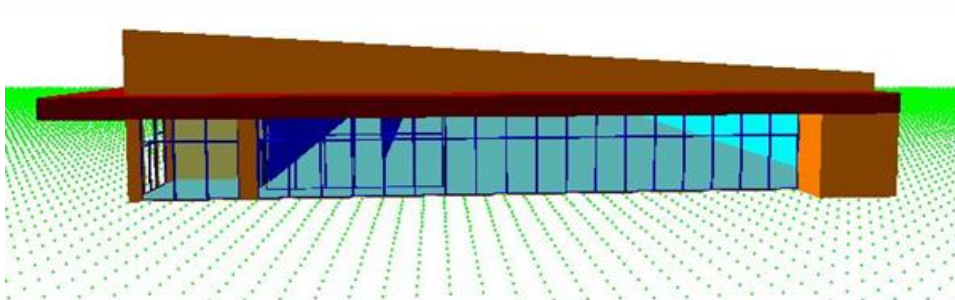

Figure 10b.

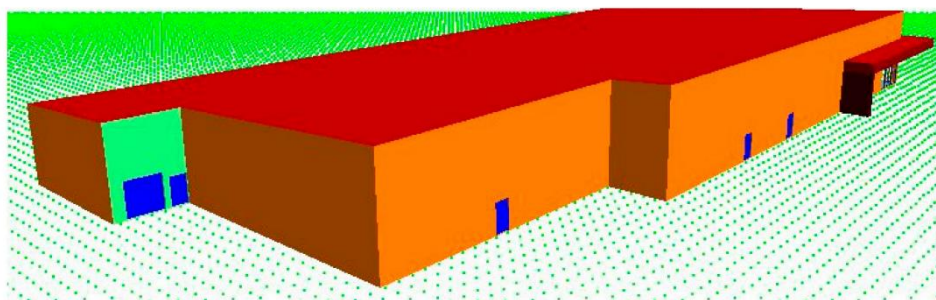

Figure 10c.

Figure 10(a–c). Baseline model building geometry (thermal analysis simulation (TAS) software).

4.7. Results and Discussion of Simulation Modelling London UK supermarket

The analysis of the baseline model supermarket based in London, UK, is presented in Figures 10a–10c. These figures represent the simulation modelling results covering different sides of the building geometry.

Table 17 shows the energy and CO₂ emissions summary from Building Regulations United Kingdom part-L (BRUKL) output. It compares the information of the actual building emissions to the notional building, including heating and cooling demand, primary energy, and total emissions.

Table 17. Energy and CO₂ emissions summary.

	Actual	National
Heating + cooling demand (MJ/m ²)	594.54	599.9
Primary energy (kWh/m ²)	348.99	306.81
Total emissions (kg/m ²)	59	53.4

Another critical parameter to compare is the external temperature of the building, which will vary depending on the weather condition. For example, figure 11 shows the plot of heat transfer vs. load breakdown on chiller building heat transfer (W), entrance lobby building heat transfer (W), and sales area building heat transfer (W).

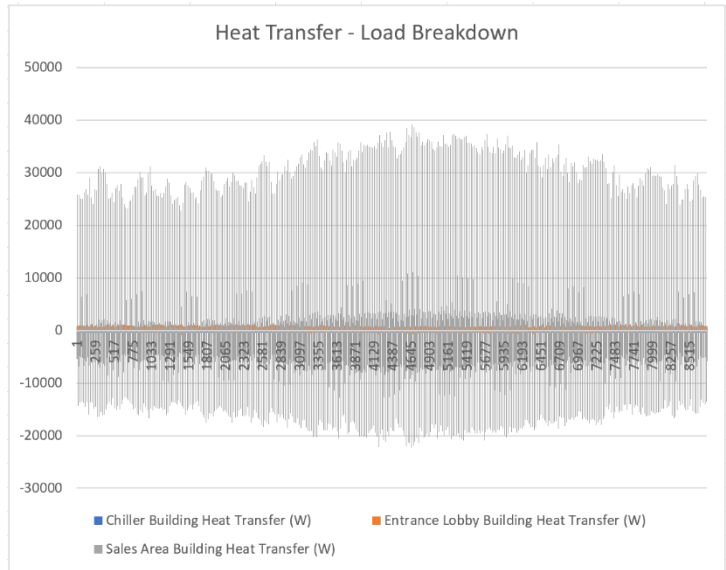

Figure 11: Building Heat Transfer Zones.

Figure 12 shows the building’s resultant temperature at a peak external temperature of 30.7°C on 14 July.

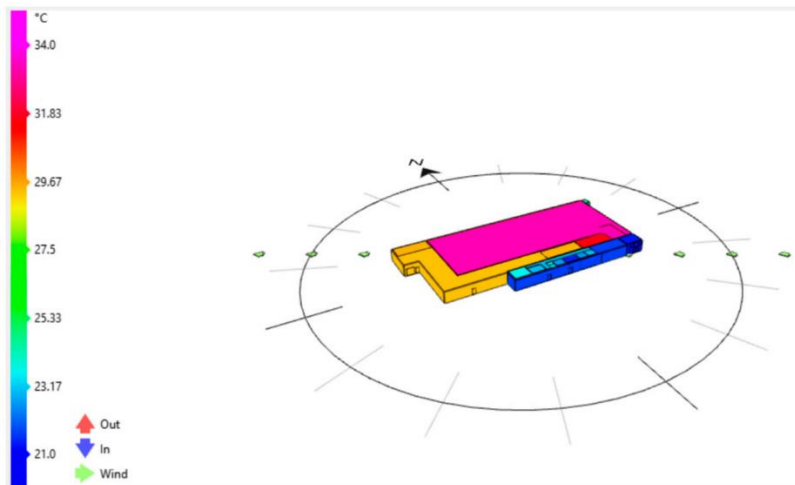

Figure 12: A 3D visualization of the building showing all the zones with their respective temperatures.

All the information in Figures 11–12 and Tables 15–17 is used for further statistical analysis.

4.7.1 Statistical Analysis of the Key Performance Indicators

The change in key performance indicators of the baseline supermarket model in current and future weather data has been presented in Tables 18a–18j. It shows the percentage variations of the building performance indicators using the future weather data timeline scenarios compared to the current weather data.

Table 18a. Annual energy consumption variation comparison under the 2050s percentile.

Baseline model	Total annual energy consumption (kWh/m ²)						
	The 2050s						
	Current (kWh/m ²)	Med (10 th)	Med (50 th)	Med (90 th)	High (10 th)	High (50 th)	High (90 th)
		% Inc	% Inc	% Inc	% Inc	% Inc	% Inc
	98.63	1.80	4.12	7.01	1.46	3.80	6.45

Table 18b. Annual energy consumption variation comparison under the 2080s percentile.

Base line model	Total annual energy consumption (kWh/m ²)									
	The 2080s									
	Current (kWh/m ²)	Low (10 th)	Low (50 th)	Low (90 th)	Med (10 th)	Med (50 th)	Med (90 th)	High (10 th)	High (50 th)	High (90 th)
		% Inc	% Inc	% Inc	% Inc	% Inc	% Inc	% Inc	% Inc	% Inc
	98.63	2.92	6.48	11.05	3.96	8.22	14.07	5.14	10.36	17.68

Table 18c. Annual CO₂ emissions variation comparison under the 2050s percentile emissions.

Baseline model	Annual CO ₂ emissions comparison (kgCO ₂ /m ²)						
	The 2050s						
	Current (kgCO ₂ /m ²)	Med (10 th)	Med (50 th)	Med (90 th)	High (10 th)	High (50 th)	High (90 th)
		% Inc	% Inc	% Inc	% Inc	% Inc	% Inc
	51.29	1.60	3.90	6.80	1.25	3.61	6.24

Table 18d. Annual CO₂ emissions variation comparison under the 2080s percentile emissions.

Base line model	Annual CO ₂ emissions comparison (kgCO ₂ /m ²)									
	The 2080s									
	Current(kgCO ₂ /m ²)	Low (10 th)	Low (50 th)	Low (90 th)	Med (10 th)	Med (50 th)	Med (90 th)	High (10 th)	High (50 th)	High (90 th)
		% Inc	% Inc	% Inc	% Inc	% Inc	% Inc	% Inc	% Inc	% Inc
	51.29	2.71	6.26	10.84	3.76	8.01	13.84	4.93	10.14	17.45

Table 18e. Annual electricity energy variation comparison for the 2050s percentile.

	Annual electricity energy comparison (kWh/m ²)						
	The 2050s						

Baseline model	Current (kWh/m ²)	Med (10 th)	Med (50 th)	Med (90 th)	High (10 th)	High (50 th)	High (90 th)
		% Inc	% Inc	% Inc	% Inc	% Inc	% Inc
	303.39	1.61	3.91	6.80	1.26	3.60	6.24

Table 18f. Annual electricity energy variation comparison for the 2080s percentile.

Baseline model	Annual electricity energy comparison (kWh/m ²)									
	The 2080s									
	Current (kWh/m ²)	Low (10 th)	Low (50 th)	Low (90 th)	Med (10 th)	Med (50 th)	Med (90 th)	High (10 th)	High (50 th)	High (90 th)
		% Inc	% Inc	% Inc	% Inc	% Inc	% Inc	% Inc	% Inc	% Inc
	303.39	2.72	6.27	10.83	3.76	8.01	13.85	4.93	10.14	17.45

Table 18g. Annual cooling energy consumption variation comparison for the 2050s percentile.

Baseline model	Annual cooling energy consumption comparison (kWh/m ²)						
	The 2050s						
	Current (kWh/m ²)	Med (10 th)	Med (50 th)	Med (90 th)	High (10 th)	High (50 th)	High (90 th)
		% Inc	% Inc	% Inc	% Inc	% Inc	% Inc
	53.74	3.00	7.29	12.67	2.36	6.70	11.63

Table 18h. Annual cooling energy variation comparison for the 2080s percentile.

Baseline model	Annual cooling energy consumption comparison (kWh/m ²)									
	The 2080s									
	Current (kWh/m ²)	Low (10 th)	Low (50 th)	Low (90 th)	Med (10 th)	Med (50 th)	Med (90 th)	High (10 th)	High (50 th)	High (90 th)
		% Inc	% Inc	% Inc	% Inc	% Inc	% Inc	% Inc	% Inc	% Inc
	53.74	5.58	11.69	20.15	7.02	14.91	25.72	9.17	18.85	32.38

Table 18i. Annual heating demand variation comparison for the 2050s percentile.

Baseline model	Annual heating energy consumption comparison (kWh/m ²)						
	The 2050s						
	Current (kWh/m ²)	Med (10 th)	Med (50 th)	Med (90 th)	High (10 th)	High (50 th)	High (90 th)
		% Dec	% Dec	% Dec	% Dec	% Dec	% Dec
	0.19	15.79	31.58	47.37	15.79	31.58	47.37

Table 18j. Annual heating demand variation comparison for the 2080s percentile.

	Annual heating energy consumption comparison (kWh/m ²)									
	The 2080s									

Base line model	Current (kWh/m ²)	Low (10 th)	Low (50 th)	Low (90 th)	Med (10 th)	Med (50 th)	Med (90 th)	High (10 th)	High (50 th)	High (90 th)
		% Dec	% Dec	% Dec	% Dec	% Dec	% Dec	% Dec	% Dec	% Dec
	0.19	26.32	47.37	68.42	26.32	52.63	73.68	31.58	63.16	84.21

4.7.1.1 Total Annual Energy Consumption Variation

Tables 18a-18b show the annual energy consumption for current and future climatic projections for the 2050s period for medium and high emission scenarios. For the 10th, 50th and 90th percentiles, and similarly for the 2080s period, it provides the energy consumption for the low, medium, and high emission scenarios. All the predicted scenarios show a constant gradual increase in energy consumption over the years, irrespective of any chosen scenario or percentile.

This trend is observed in all the emission scenarios, with a peak increase of 7.01% in the 2050s medium (90th) percentile scenario and a 17.68% increase in the 2080s high (90th) percentile scenario, respectively. This rise in energy consumption follows the range of annual average temperature variation predicted by the IPCC scenarios showing a gradual increase in the temperature over time. The increased energy consumption over the years is attributed to the increased cooling demand in the face of increasing climatic temperature.

4.7.1.2 Total Carbon Dioxide (CO₂) Emissions Variation

Tables 18c-18d show the annual building CO₂ emissions for current and future climatic projections for the 2050s period, for medium and high emission scenarios and 10th, 50th and 90th percentiles, and similarly for the 2080s period. In addition, it provides the annual building CO₂ emissions for the low, medium, and high emission scenarios. All the predicted scenarios show a constant gradual increase in carbon dioxide emissions over the years, irrespective of the chosen scenario or percentile.

This trend is observed in all the emission scenarios, with a peak increase of 6.80% in the 2050s medium (90th) percentile scenario and a 17.45% increase in the 2080s high (90th) percentile scenario, respectively. This rise in carbon dioxide emissions is by the range of annual average temperature variation predicted by the IPCC scenarios showing a gradual increase in the temperature over time. The increased emissions over the years are attributed to the increased cooling demand, using more electricity to match the increased energy demand in the face of increasing climatic temperature.

4.7.2 Annual Electricity Grid Comparison Analysis

Tables 18e and 18f show the annual electricity consumption for current and future climatic projections for the 2050s period for medium and high emission scenarios. For the 10th, 50th and 90th percentiles, and similarly for the 2080s period, it provides the annual building electricity consumption for the low, medium, and high emission scenarios. All the predicted scenarios

show a constant gradual increase in energy consumption over the years, irrespective of the chosen scenario or per centile.

This trend is observed in all the emission scenarios, with a peak increase of 6.80% in the 2050s medium (90th) percentile scenario and a 17.45% increase in the 2080s high (90th) percentile scenario, respectively. This rise in the annual electricity consumption is by the range of annual average temperature variation predicted by the IPCC scenarios showing a gradual increase in the temperature over time. The increased emissions over the years are attributed to the increased cooling energy demand as more electricity is used to match the increased cooling demand in the supermarket.

4.7.2.1 Percentage of Cooling Demand Variation

Tables 18g and 18h show the annual cooling energy consumption for current and future climatic projections for the 2050s period, medium and high emission scenarios and the 10th, 50th and 90th percentiles. Similarly, for the 2080s period, it provides the annual building cooling energy consumption for the low, medium, and high emission scenarios. All the predicted scenarios show a constant gradual increase in cooling energy consumption over the years, irrespective of the chosen scenario or percentile.

This trend is observed in all the emission scenarios, with a peak increase of 12.67% in the 2050s medium (90th) percentile scenario and a 32.38% increase in the 2080s high (90th) percentile scenario, respectively. This rise in the annual electricity consumption is by the range of annual average temperature variation predicted by the IPCC scenarios showing a gradual increase in the temperature over time. Therefore, the increased cooling consumption over the years is attributed to the increasing external temperature, thus increasing the need for cooling in the supermarket.

4.7.2.2 Percentage of Heating Demand Reduction

Tables 18i and 18j show the annual heating consumption for the current and future climatic projections. Future climatic projections for the 2050s period, for medium and high emission scenarios and 10th, 50th and 90th percentiles, and similarly for the 2080s period. In addition, it provides the annual building heating demand for the low, medium, and high emission scenarios. All the predicted scenarios show a constant gradual decrease in energy consumption over the years, irrespective of the chosen scenario or percentile.

This trend is observed in all the emission scenarios, with a peak reduction of 47.37% in the 2050s medium (90th) percentile/high (90th) percentile scenario and an 84.21% reduction in the 2080s high (90th) percentile scenario, respectively. This fall in the annual heating consumption is by the range of annual average temperature variation predicted by the IPCC scenarios showing a gradual increase in the temperature over time. Therefore, the reduced heating consumption over the years is attributed to the increased climatic temperature influencing the heating demand to be minimised.

The study, therefore, points to the fact that an increase in future temperature due to climatic variation would significantly decline heating demand and, conversely, increase the cooling demand in the supermarket industry.

4.7.3 Analysis and Comparison of Significant Parameters under the Worst-Case Scenario

To understand the far-reaching effects of the climatic variation on the heating, cooling, and other significant parameters of the supermarket industry, simulations were run for the current weather data scenario and the worst-case scenario of the 2080s high (90th) percentile. The results are presented in Figures 13–24 showing the variations as graphs of temperature and loads and total load profile for the building between the three warmest months of the year (June 1 to August 31) for the current weather and the 2080s high (90th) percentile. In contrast, for the heating profile, the three coldest months were used (January 1 to April 4), and all these simulations were run using the TRY weather files.

4.7.3.1 Analysis and Comparison of External Temperature

The future predicted climate variation of the 2080s clearly shows a high upsurge in the temperature compared to the current weather data. The external temperature for the current weather data and the worst-case scenario of the 2080s high (90th) percentile show that the external temperature ranges from 6°C to 30.7°C, with relatively few periods above the 30°C mark for the current weather data. However, for the worst-case scenario, the external temperature ranges from 9.4°C to 36.6°C, with 55 occurrences above the 30°C mark, for the specified analysis period, respectively.

Chapter 5: A comparative study of supermarket building performance under Current and future weather conditions: UK case study.

5.1 Problem statement

In today's developed world, around 75% of the population lives in urban areas (UN report 2014). According to the planning policy outlined by the 'Communities and Local Government' (DCLG) department of the UK government ", England is one of the most crowded countries in the world with over 90% of its population living in urban areas covering just 8% of the land area" (DCLG 2020). It points out that the impact of future climate change needs to be addressed immediately, specifically in the UK's urban built environment (Eltges 2010).

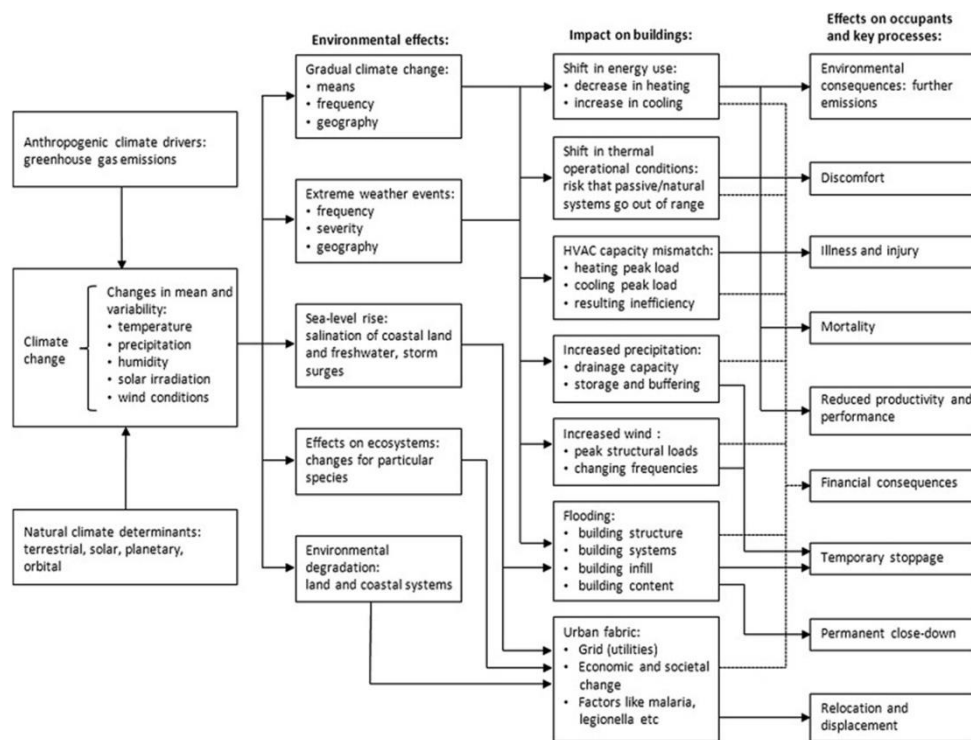

Figure 13. Schematic summary of the pathways of how climate change impacts environmental effects on buildings and subsequently on building's occupants (McMichael, Woodruff & Hales 2006).

The local weather of any building dictates the energy needs of the building (Ciancio et al., 2018). Based on this, it can be inferred that the regional and local weather patterns around the globe will dictate the energy usage and, subsequently, the carbon and GHG emissions for the existing buildings in the area (Andrić et al., 2017). As per the new weather conditions, these buildings will change the civil sector requirements regarding their primary energy demand (Zhai & Helman, 2019). Therefore, the international building community is keen on analysing the relationship between climate change, energy demand and greenhouse gas emissions to predict the future energy consumption of their buildings (Guan 2009) and the worsening effect due to future weather conditions (de Wilde & Coley, 2012).

Figure 13 shows the intricate relationship between the outdoor environment of a building exposed to climate change and the building's indoor environment, which needs to be kept within a range of values so that the occupants/users of the building feel safe, comfortable and healthy. In the figure, from left to right: (a) climate change as a driving force; (b) direct effect on the environment on buildings because of climate change; (c) the resultant impact of the environmental effects on the buildings; and (d) possible consequences on the occupants/users of the building with critical processes taking place in buildings.

A supermarket's primary purpose is selling goods, foods, and services from contractors to the users for personal use (Burns 1996). According to one report, the UK has over 87,000 supermarkets operating nationwide (Retail Foods USDA 2019). The UK building sector accounts for approximately 3% of total electricity use, and UK supermarkets and similar organisations are responsible for 1% of the total UK GHG emissions.

These buildings have high energy use intensity (EUI) due to increased refrigeration and lighting needs (Tassou et al. 2011). To address the issue of needing weather files to forecast the future climate of specific locations, several researchers have investigated the effect of regional geographical climate on the energy consumption and carbon emissions of the supermarkets in the area. From one research project, a considerable proportion of the buildings in the UK perform poorly during hot weather waves reinforcing the idea of an appropriate climate change future weather files to study the buildings' performance assessment at regular intervals (Nicol & Humphreys 2007).

In 2019, a group of researchers created a database of weather patterns and climate change to represent the future climatic conditions of Geneva (Switzerland). It was set according to the peculiarities of the area under consideration and for various global warming scenarios (Moazami et al. 2019). In the UK, Kershaw et al. created an example of a probabilistic approach to climate file for future weather conditions, which was then validated for Plymouth (UK), known as 'The UK Climate Projections 2009' (Kershaw, Eames & Coley 2011).

Background research investigating how buildings' energy analysis and GHG emissions correspond to future climate conditions yielded interesting results.

In the face of climatic change and a race to achieve weatherproofing of buildings, the scientific community around the globe has a vested interest in investigating the effect of climate change on energy consumption and carbon emissions related to the heating and cooling of buildings (Ciancio et al. 2020).

Despite all the studies and research literature regarding the energy and carbon emissions of buildings worldwide, minimal data is available after the creation of the UK Climate Projections (UKCP09). Moreover, quite recently, the Chartered Institution of Building Services Engineers (CIBSE) has provided an accurate data set of climate projections so that the researchers can conduct experiments with future weather simulations. Although the effect of climate change on energy and carbon emissions in different building types has been investigated for various locations in the UK and around the world, no such investigation has been performed for supermarkets in Great Britain's climatic regions (Braun et al., 2016).

This study investigates the impact of future climate change on the annual energy usage and carbon emissions of a typical supermarket across four different UK cities. This research will consider a standard baseline model for a typical supermarket in London. An identical model is

designed in other cities across the UK with regional climates in Manchester, Southampton, and Norwich. A series of simulations will be performed in a computational fluid dynamic (CFD) building software package with the help of CIBSE-provided UKCP09 weather current and future weather data files. Dynamic hourly simulations were performed for each location and incorporated into a graphical presentation to represent the peaks and falls to make the results wholly accurate and detailed.

5.2. Building energy performance simulation software

One of the most critical steps in the methodology is choosing a simulation platform that can produce dynamic modelling simulations and use the weather file type provided by the CIBSE institute. Due to the increasing complexity of the building design and functionality, the building performance assessment has become an integral part of building services consultants' planning and design process. The most used programs today by engineering consultancy firms in the UK include DesignBuilder (2020), Hevacomp (2020), IES Virtual Environment (IE 2020) and TAS Building Designer (2020) (Jentsch, Bahaj & James 2008).

Out of all the software packages stated, DesignBuilder and Hevacomp represent user interfaces using the simulation engine EnergyPlus (2020). However, as an open-source code software, it needs the extensive graphical user interface (GUI) made available by the Department of Energy, the USA, making it unfit for the study. On the other hand, TAS-EDSL and IES use individual calculations with several underlying software products and data exporting capabilities (Crawley et al 2008). Furthermore, all of the software packages are approved to be used in compliance checking for the Building Regulations guidance 2006: Part L2 for England and Wales (Pan and Garmston, 2012) and come integrated with the Building Research Establishment (BRE) software tool 'Simplified Building Energy Model (SBEM) for analysis of building energy consumption (SBEM BRE 2020). However, the best software for the investigation would be TAS- EDSL, which has approved dynamic modelling routines that assist with producing hourly data and comprehensive graphical details.

5.2.3 3D Modelling of Thermal Analysis Simulation (TAS-EDSL):

As discussed already in simulating the thermal needs of residential and non-residential buildings, the dynamic modelling version 9.5.0 of TAS EDSL assists as a potent modelling and simulation tool for the optimisation of the building environment, energy efficiency, and occupant comfort, and it provides a comprehensive solution (TAS, EDSL). (Bahadori-Jahromi et al., 2017).

A baseline model of a typical UK supermarket store is designed in the TAS EDSL software package. Since all the supermarket stores under experimentation are based in the UK, the current and future CIBSE TRY weather files are chosen for evaluation purposes provided by CIBSE.

5.2.4 Weather files used in simulation packages

A common feature in all the software packages is weather files used in building performance simulations based on specific locations. Conventionally, the weather files used are hourly data sets and available in various formats depending on their geographical location.

One of the most used formats of weather files is the hourly data format files known as Typical Meteorological Year (TMY2) files, published by the US National Renewable Energy Laboratory (NREL) in the early 1990s (Guggenberger, Elmore & Crow 2013). TMY2 files are usually derived from the measured 1961–1990 weather data set. They are available in the format of hourly values of solar radiation and meteorological parameters for a 'typical' one-year time period. However, the weather files generated from long-term calculated data using statistical analysis, such as TMY2 files, are primarily suited for predicting a building's average energy demand for heating, cooling and ventilation. They exclude essential parameters such as peak year conditions, thus making them unsuitable for overheating assessment of naturally ventilated buildings (Jentsch, Bahaj & James 2008).

To overcome this issue and focus on the UK's weather files, CIBSE has produced two different simulation weather file sets. Test Reference Year (TRY) files for HVAC planning and Design Summer Year (DSY) files for overheating analysis (CIBSE Guide J, 2002). Since 2006, CIBSE weather files of TRY and DSY have been available for 14 sites throughout the UK using improved selection algorithms (Levermore & Parkinson 2006). The data available are presented as TRY and DSY based on UKCP09 climate change scenarios. In addition, they have low, medium, and high carbon emission scenarios with varying probabilities of 10th, 50th, and 90th percentiles (Virk et al., 2015). These up-to-date files are used in the study, and each city uses its weather data set according to its nearest weather station. The current TRY and DSY were morphed to incorporate the UKCP09 climate change scenarios of the periods and the emission scenarios to limit any uncertainties that could affect the weather data (Eames, Kershaw & Coley 2010).

5.2.5 City Selection Criteria

The cities were selected after thorough consideration, considering the regional climates in the UK. As there must be a weather station near the chosen location, a table was generated to ensure the selected cities and the weather station are compatible. The chosen cities were in different regional climates for a good comparative view of the changing climate. The UK has eleven regional climates based on climate characteristics such as temperature, sunshine, rainfall, snowfall, and wind (UK regional climates 2021). These regions are:

1. Scotland (Northern, Eastern, Western)
2. Northern Ireland
3. Wales
4. Midlands
5. England (Northwest & Isle of Man, Northeast, Eastern, Southern, South West)

Out of these regional climates, a cross-over table with CIBSE provided 'current' and 'future' weather files in Table 18.

Table 19. UK regional climates and selected cities.

UK Regional Climate	City Selected
North-West England & Isle of Man	Manchester
Eastern England	Norwich
Southern England	Southampton
England South-East & Central South	London

The table shows that each city is in a different UK regional climate. Therefore, various selected cities give invaluable insight into climate change's future and direct effects as they have significantly different climatic characteristics. Furthermore, they show how drastically the key performance indicators can change in the coming years due to climate change.

5.2.6 Simulation Process Research flow

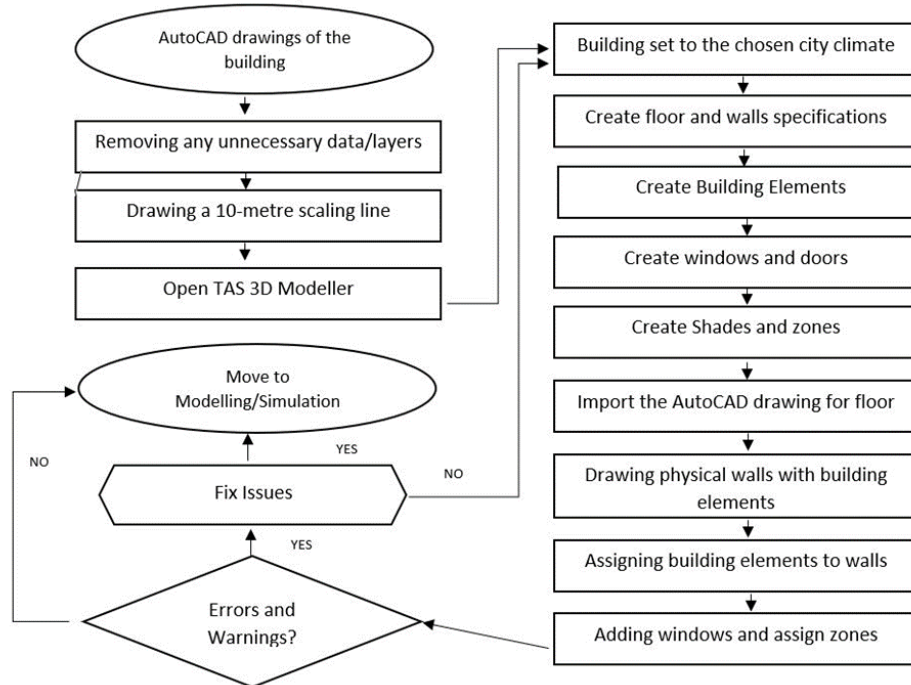

Figure 14. Research flow for preparation to the pre-modelling stage.

5.2.7 Simulation (Performance parameter selection for simulation)

To eliminate any errors/warnings in the design process, the TAS modeller undergoes a range of performance parameters and assumptions, including the building summary, calendar year, weather database, building elements, zones, internal conditions, and schedules to simulate the building properly. Figure 14 shows a flowchart representing the multiple stages in the supermarket building model from the AutoCAD drawings with various steps involved.

Table 19 summarises simulation assumptions regarding the fabric specification modelled in the TAS EDSL software. Similarly, Table 20 shows the building summary specification, whereas Table 21 shows the building materials' thermophysical characteristics, representing the construction modelling of a typical supermarket building.

Table 20. Simulation assumptions: building fabric specification.

Building element	Calculated area-weighted average U-values (W/m ² K)
Wall	0.24
Floor	0.21
Roof	0.13
Windows	3.08
Personnel doors	1.32

Vehicle access doors	1.78
High-usage entrance doors	3.34

Table 21. Simulation assumptions: building summary specification.

Calendar	NCM standard
Air permeability	5.0 m ³ /h.m ² @ 50Pa
Infiltration	0.125 (ACH)
Fuel source	Grid supplied electricity
CO ₂ factor	0.519 kg/kWh

Table 22. Construction details: specifications of thermophysical characteristics.

Type		Conductance (W/m ² . °C)	Solar Absorptance		Emissivity	Time Constant	Construction Type
			External/Interna l	External/Interna l			
Wall	Cast Concrete wall	0.974	0.700	0.900	4.169	Opaque	
	Cavity wall	0.25	0.700	0.900	12.790	Opaque	
	Curtain Wall	5.227	0.700	0.900	0.0	Opaque	
	Metal Cladding Wall	0.235	0.700	0.900	0.0	Opaque	
	Steel Frame Wall	0.379	0.700	0.900	2.526	Opaque	
Frame	Uncoated glass, air-filled	5.545	0.101	0.078	0.840	0.00	Transparent
	Metal, thermal break & spacer	59.116	0.00		0.850	0.00	Transparent
	Wood, thermal spacer	7.89	0.00		0.850	0.00	Transparent
Floor	Ground Floor	0.218	0.700	0.900	156.820	Opaque	
Door	Insulated personal door	0.94	0.700	0.900	0.00	Opaque	
	Vehicle door	2.0	0.700	0.900	0.00	Opaque	

5.3 UK Climate Projections (UKCP) Projections:

As discussed, The Met Office Hadley Centre Climate Programme's UK Climate Projections (UKCP), a climate analysis tool, provides the most recent and reliable climate projections for buildings located in the UK. For test reference years (TRY) and design summer years (DSY), these forecasts are given in three emission scenarios: high, medium, and low. More information is provided in the study (Hasan et al., 2020).

5.3.1 Current climate weather data

The current climate weather data includes the data of a specific geographical location resulting from hourly observation as a meteorological service, usually in areas adjacent to the location. It consists of months selected from individual years and concatenated to form an entire year. The intended use is for computer simulations of solar energy conversion and building systems (Hall et al. 1978).

5.3.2 Future climate weather data

The future climate weather data includes 8760 hourly values of the weather variables for each specific location. In addition, the CIBSE institute produced climate change weather files for 2050 and 2080 for all the selected UK locations. Both types of weather data (Current and Future) are created using a "morphing" procedure (Mavrogianni et al. 2011) by making use of outputs from UK Hadley Centre Coupled Model (version 3, HadCM3), a General Circulation Model (GCM) assessing the climate change. Weather metrics included in HadCM3 files data are temperature (°C), maxima and minima temperature (°C), total incident solar radiation (W/m²), total downward surface shortwave flux (W/m²), total cloud in long-wave radiation (fraction), total precipitation change (%), relative humidity (fraction), mean sea level pressure (hPa), wind speed change (%) (Ciancio et al. 2018).

5.3.3 Data Collection

Live data was collected from LIDL head offices to verify the degree to which the selected stores were comparable with the actual operation of the supermarkets; as a part of data collection, the following information was gathered:

- EPC certificates of all the stores in the study
- Annual energy usage by calculating the grid-supplied electricity (kWh)
- Annual GHG emissions of the store

Since the baseline supermarket model is designed as the '*standardised*' supermarket building, it is considered that the baseline model in all the chosen cities is identical. Hence, the supermarkets were considered sufficiently like be used for the investigation here to achieve the research aims. A data collection phase is shown below as a part of the flowchart in Figure 15.

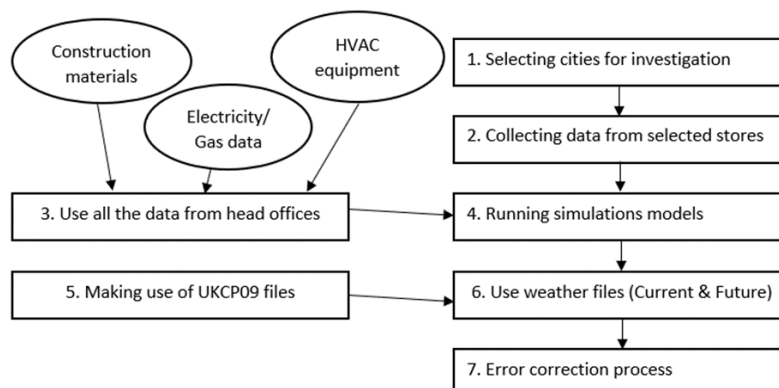

Figure 15. Research flow for supermarkets investigation.

5.4 Results obtained from the cities taken as a case study.

Since the study investigates the impact of climate change on multiple cities across the UK, a thorough examination is conducted to produce results for each city, focusing on parameters such as energy consumption, carbon emissions, cooling, and heating. They are compared to highlight their substantial differences based on location and local and regional climate.

5.4.1 London model

As a standard practice with all 3-D modelling and CFD simulations, a baseline model is initially modelled, tested, and validated in the current conditions. The readings from TAS software provide a detailed account of heating, cooling, DHW, lighting, equipment, and auxiliary energy consumption.

5.4.1.1 Current weather scenario

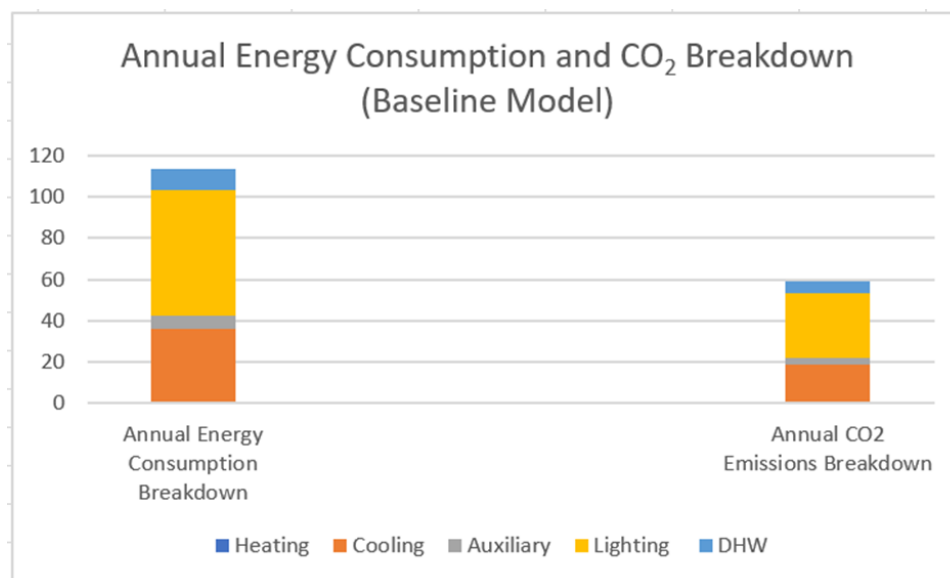

Figure 16. Annual Energy Consumption and CO₂ Breakdown.

The annual energy consumption and CO₂ emissions breakdown of the baseline building modelled in London is shown Figure 16. This scenario is under the current weather.

As shown, due to the high energy use nature of the supermarket, the most dominant section is the lighting, with cooling being the second highest energy consumption area. Similarly, the associated annual CO₂ emissions represent the most significant emissions sector, with cooling being the second. Given the shop floor's area and lighting in rooms, offices, toilets, and other areas, it will require the most energy and produce the most emissions. The total annual energy comes to 112.33 kWh/m², whereas the emissions are 58.30 kgCO₂/m², with heating and cooling at 0.21 and 33.76 kWh/m², respectively.

5.4.1.2 Future weather scenarios

Under the future weather files of the 2050s and 2080s with their various emission scenarios, experiments are conducted to see the difference in the supermarket model's energy, emissions,

heating, and cooling. Since there are six and nine different emissions scenarios under the 2050s and 2080s, respectively, provided by CIBSE, several simulations were run and validated to ensure the resultant data is accurate and the percentage increase/decrease recorded reflects the weather data used.

5.4.1.3 Energy & CO₂ emissions

Figure 17 shows the annual energy and carbon dioxide consumption for future climatic projections for the 2050s period, medium and high emission scenarios, and 10th, 50th, and 90th percentiles. Similarly, for the 2080s period, the figure provides the energy and emissions consumption for the low, medium, and high emission scenarios. All the predicted scenarios show a constant gradual increase in energy consumption over the years, irrespective of the chosen scenario or percentile.

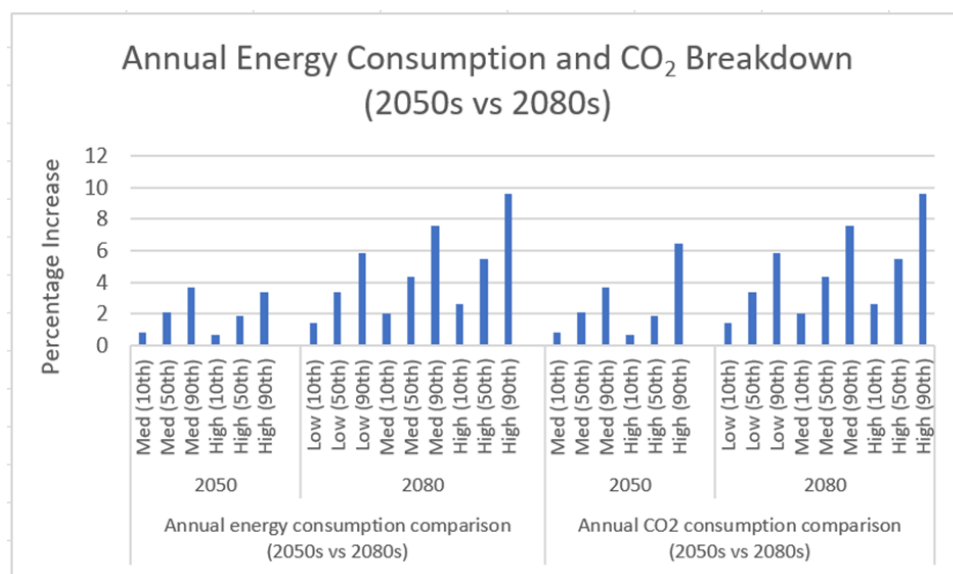

Figure 17. Annual energy and CO₂ consumption comparison (the 2050s vs 2080s).

For energy consumption, the trend is observed in all the emission scenarios, with a peak increase of 3.66% in the 2050s medium (90th) percentile scenario and a 9.58% increase in the 2080s high (90th) percentile scenario, respectively.

For carbon emissions, the trend is observed in all the emission scenarios, with a peak increase of 3.65% in the 2050s medium (90th) percentile scenario and a 9.59% increase in the 2080s high (90th) percentile scenario, respectively.

The increased consumption over the years is attributed to the increased cooling demand in the face of increasing climatic temperature.

The data presented in Figure 17 is derived from simulations that project future energy and carbon dioxide consumption based on various emission scenarios and percentiles. These scenarios and percentiles represent different potential trajectories of greenhouse gas emissions and their associated impacts on climate. For the 2050s, we considered both medium and high emission scenarios across the 10th, 50th, and 90th percentiles. The percentiles provide a range

of possible outcomes, with the 10th percentile being a more conservative estimate and the 90th percentile being a more extreme estimate. For the 2080s, we expanded our analysis to include low, medium, and high emission scenarios. The observed trend of increasing energy and carbon emissions across all scenarios and percentiles indicates a consistent pattern of rising energy demands, especially for cooling, as global temperatures rise. The specific percentages mentioned, such as the 3.66% increase in the 2050s medium (90th) percentile scenario, are derived from the difference between the projected values for that scenario and the baseline or current values. These figures underscore the significant impact of climate change on energy consumption and emissions in the coming decades.

5.4.1.4 Heating & Cooling comparison

Figure 18 shows the annual heating and cooling energy comparison for future climatic projections for the 2050s period, medium and high emission scenarios, and 10th, 50th, and 90th percentiles. Similarly, for the 2080s period, the figure provides the heating and cooling energy consumption for the low, medium, and high emission scenarios. All the predicted heating energy scenarios show a gradual decrease over the years, irrespective of the chosen scenario or percentile. In contrast, the cooling energy increases regardless of any scenario chosen.

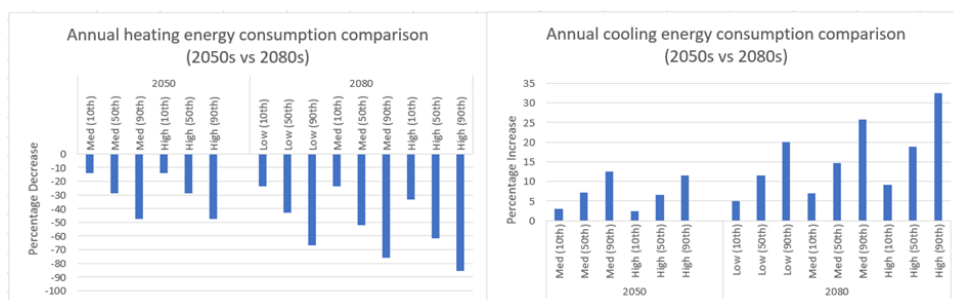

Figure 18. Annual heating and cooling energy consumption comparison (the 2050s vs 2080s).

For heating energy, the trend is observed in all the emission scenarios, with a peak reduction of 47.62% in the 2050s medium (90th) percentile/high (90th) percentile scenario and an 85.72% reduction in the 2080s high (90th) percentile scenario, respectively. It shows a gradual decrease in the temperature over time. Over the years, the reduced heating consumption has been attributed to the increased climatic temperature influencing the heating demand to be minimised.

For cooling energy, the trend is observed in all the emission scenarios, with a peak increase of 12.47% in the 2050s medium (90th) percentile scenario and a 32.41% increase in the 2080s high (90th) percentile scenario, respectively. This rise in the annual cooling energy consumption shows a gradual increase in the temperature over time. Therefore, over the years, the increased cooling consumption has been attributed to the increasing external temperature, thus increasing the need for cooling in supermarket buildings.

5.4.2 Manchester model

An identical model of the supermarket building is in Manchester, North-West England. Similar experiments are conducted to gather possible results for annual energy consumption, carbon dioxide emissions, heating energy, and cooling energy consumption.

5.4.2.1 Current weather scenario

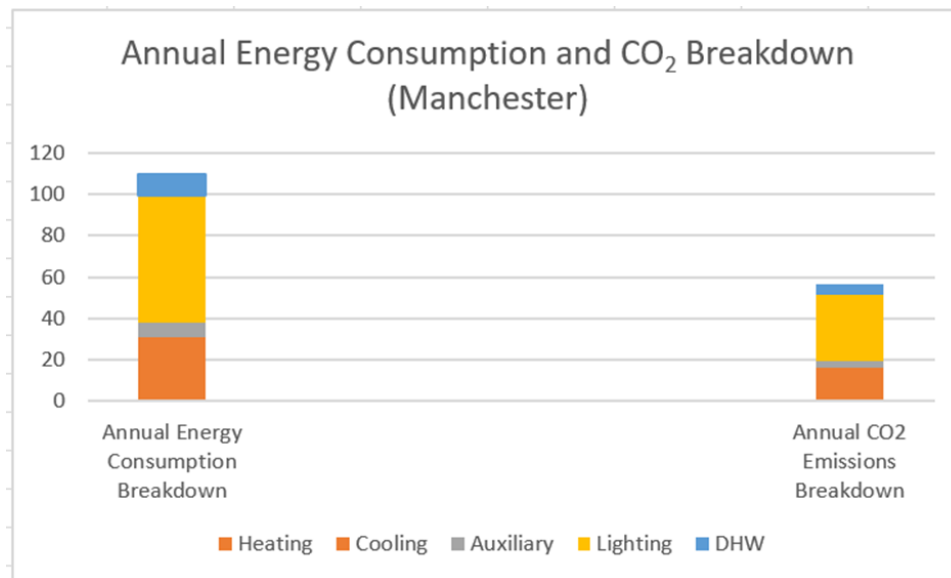

Figure 19. Annual Energy Consumption and CO₂ Breakdown.

The annual energy consumption and CO₂ emissions breakdown of the baseline building modelled in Manchester is presented in Figure 31.

The total annual energy for the current weather scenario for a typical supermarket building in Manchester is 109.45 kWh/m². The emissions are 56.81 kgCO₂/m², with heating and cooling at 0.14 and 15.99 kWh/m² respectively.

5.4.2.2 Future weather scenarios

For the expected weather data for the years 2050 and 2080, simulations examine the supermarket model's energy use, emissions, heating, and cooling under the various emission scenarios.

For the years 2050 and 2080, respectively, there are six and nine potential emission scenarios. Therefore, several simulations were run and confirmed to estimate the percentage gain or loss for the primary performance measures.

5.4.2.3 Energy & CO₂ emissions

Figure 32 shows the annual energy and carbon dioxide consumption for future climatic projections for the 2050s period, medium and high emission scenarios, and 10th, 50th, and 90th percentiles. Similarly, for the 2080s period, the figure provides the energy and emissions consumption for the low, medium, and high emission scenarios. All the predicted scenarios

show a constant gradual increase in energy consumption over the years, irrespective of the chosen scenario or percentile.

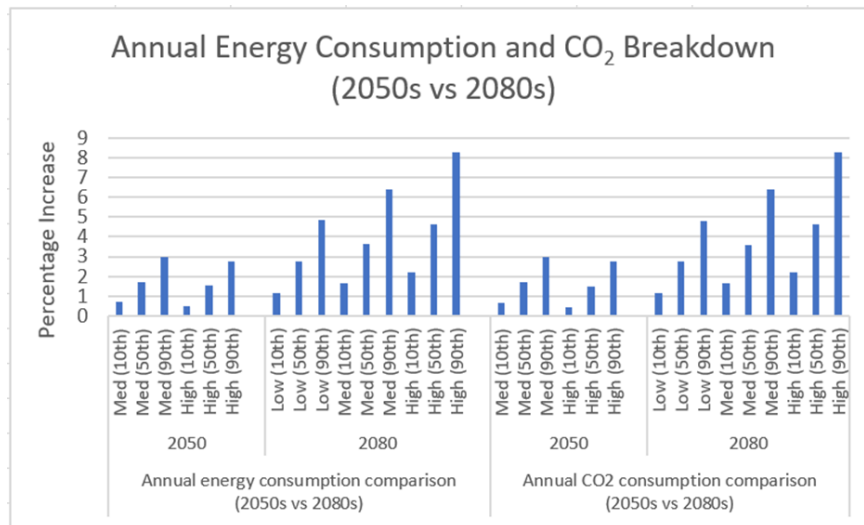

Figure 20. Annual energy and CO₂ consumption comparison (the 2050s vs 2080s).

For energy consumption, the trend is observed in all the emission scenarios, with a peak increase of 3.00% in the 2050s medium (90th) percentile scenario and an 8.30% increase in the 2080s high (90th) percentile scenario, respectively.

For carbon emissions, the trend is observed in all the emission scenarios, with a peak increase of 2.99% in the 2050s medium (90th) percentile scenario and an 8.29% increase in the 2080s high (90th) percentile scenario, respectively.

The increased consumption over the years is attributed to the increased cooling demand in the face of increasing climatic temperature.

5.4.2.4 Heating & Cooling comparison

Figure 33 shows the annual heating and cooling energy comparison for future climatic projections for the 2050s period, medium and high emission scenarios, and 10th, 50th, and 90th percentiles. Similarly, for the 2080s period, the figure provides the heating and cooling energy consumption for the low, medium, and high emission scenarios.

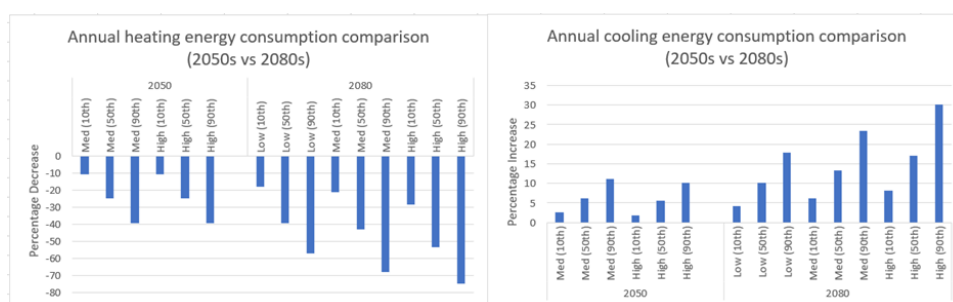

Figure 21. Annual heating and cooling energy consumption comparison (the 2050s vs 2080s).

All the predicted heating energy scenarios show a gradual decrease over the years, irrespective of the chosen scenario or percentile. In contrast, the cooling energy increases irrespective of any scenario chosen.

For heating energy, the trend is observed in all the emission scenarios, with a peak reduction of 39.29% in the 2050s medium (90th) percentile/high (90th) percentile scenario and a 39.29% reduction in the 2080s high (90th) percentile scenario, respectively. It shows a gradual decrease in the temperature over time. Over the years, the reduced heating consumption has been attributed to the increased climatic temperature influencing the heating demand to be minimised.

For cooling energy, the trend is observed in all the emission scenarios, with a peak increase of 11.00% in the 2050s medium (90th) percentile scenario and a 30.11% increase in the 2080s high (90th) percentile scenario, respectively. This rise in the annual cooling energy consumption shows a gradual increase in the temperature over time. Therefore, over the years, the increased cooling consumption has been attributed to the increasing external temperature, thus increasing the need for cooling in supermarket buildings.

5.4.3 Southampton model

An identical supermarket building model is modelled in Southampton, a coastal city in the South of England. A series of experiments are conducted to gather all possible resultant values for annual energy consumption, carbon dioxide emissions, heating energy, and cooling energy consumption.

5.4.3.1 Current weather scenario

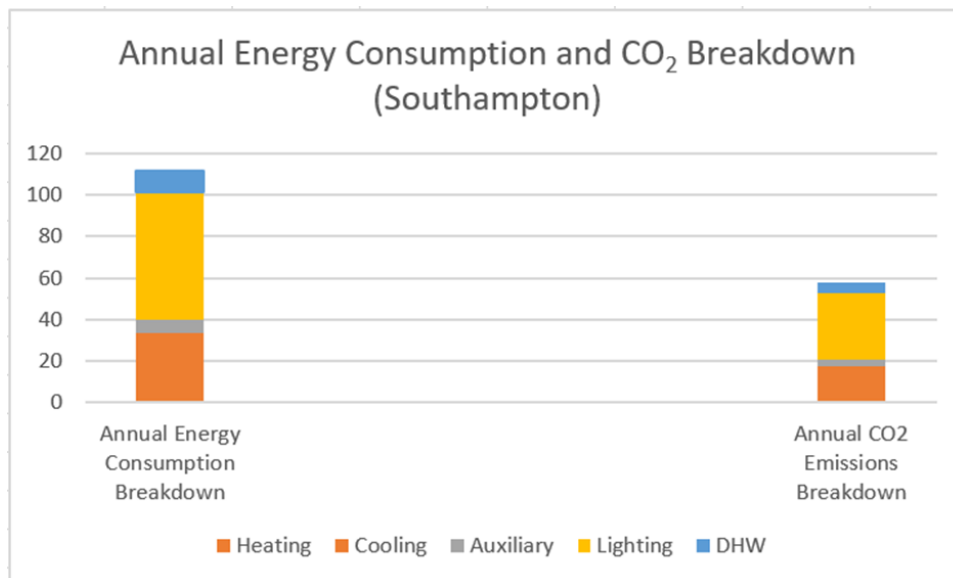

Figure 22. Annual Energy Consumption and CO₂ Breakdown.

The annual energy consumption and CO₂ emissions breakdown of the baseline building modelled in Southampton is presented in Figure 34.

The total annual energy for the current weather scenario for a typical supermarket building in Southampton is 111.63 kWh/m². In contrast the emissions are 57.94 kgCO₂/m², with heating and cooling at 0.12 and 17.15 kWh/m², respectively.

5.4.3.2 Future weather scenarios

Under the future weather files of the 2050s and 2080s with their various emission scenarios, simulations are conducted to see the difference in the supermarket model's energy, emissions, heating, and cooling.

There are six and nine emissions scenarios under the 2050s and 2080s, respectively, provided by CIBSE. In addition, several simulations were run and validated to determine the percentage increase/decrease for the key performance indicators.

5.4.3.3 Energy & CO₂ emissions

Figure 35 shows the annual energy and carbon dioxide consumption for future climatic projections for the 2050s period, medium and high emission scenarios, and 10th, 50th, and 90th percentiles. Similarly, for the 2080s period, the figure provides the energy and emissions consumption for the low, medium, and high emission scenarios. All the predicted scenarios show a constant gradual increase in energy consumption over the years, irrespective of any scenario or percentile that was chosen.

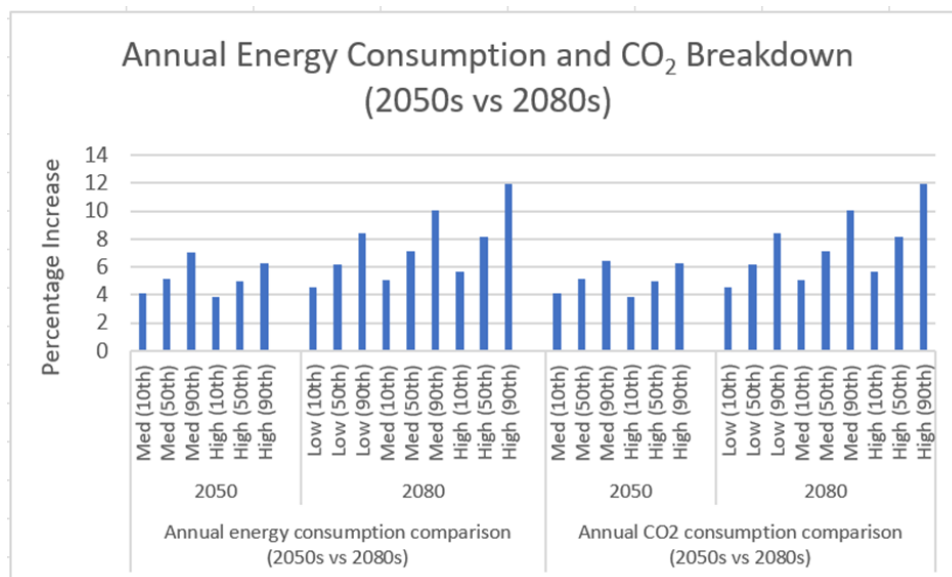

Figure 23. Annual energy and CO₂ consumption comparison (the 2050s vs 2080s).

For energy consumption, the trend is observed in all the emission scenarios, with a peak increase of 3.73% in the 2050s medium (90th) percentile scenario and a 10.04% increase in the 2080s high (90th) percentile scenario, respectively.

For carbon emissions, the trend is observed in all the emission scenarios, with a peak increase of 3.72% in the 2050s medium (90th) percentile scenario and a 10.02% increase in the 2080s high (90th) percentile scenario, respectively.

The increased consumption over the years is attributed to the increased cooling demand in the face of increasing climatic temperature.

5.4.3.4 Heating & Cooling comparison

Figure 36 shows the annual heating and cooling energy comparison for future climatic projections for the 2050s period, medium and high emission scenarios, and 10th, 50th, and 90th percentiles. Similarly, for the 2080s period, the figure provides the heating and cooling energy consumption for the low, medium, and high emission scenarios.

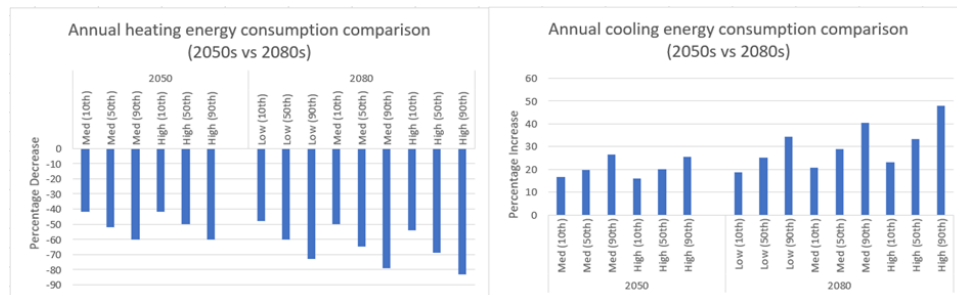

Figure 24. Annual heating and cooling energy consumption comparison (the 2050s vs 2080s).

In contrast to the cooling energy, which increases regardless of the chosen scenario, all the forecasted heating energy scenarios demonstrate a steady, gradual decline in heating energy throughout the years.

For heating energy, the trend is observed in all the emission scenarios, with a peak reduction of 40.91% in the 2050s medium (90th) percentile/high (90th) percentile scenario and a 72.72% reduction in the 2080s high (90th) percentile scenario, respectively. It shows a gradual decrease in the temperature over time. Over the years, the reduced heating consumption has been attributed to the increase in climatic temperature, influencing the heating demand to be minimised.

For cooling energy, the trend is observed in all the emission scenarios, with a peak increase of 12.91% in the 2050s medium (90th) percentile scenario and a 34.43% increase in the 2080s high (90th) percentile scenario, respectively. This rise in the annual cooling energy consumption shows a gradual increase in the temperature over time. Therefore, over the years, the increased cooling consumption has been attributed to the increasing external temperature, thus increasing the need for cooling in supermarket buildings.

5.4.4 Norwich model

Another identical supermarket building model is modelled in Norwich, a Norfolk city in the East of England. Similar experiments are conducted to gather all possible results for annual energy consumption, carbon dioxide emissions, heating energy, and cooling energy consumption.

5.4.4.1 Current weather scenario:

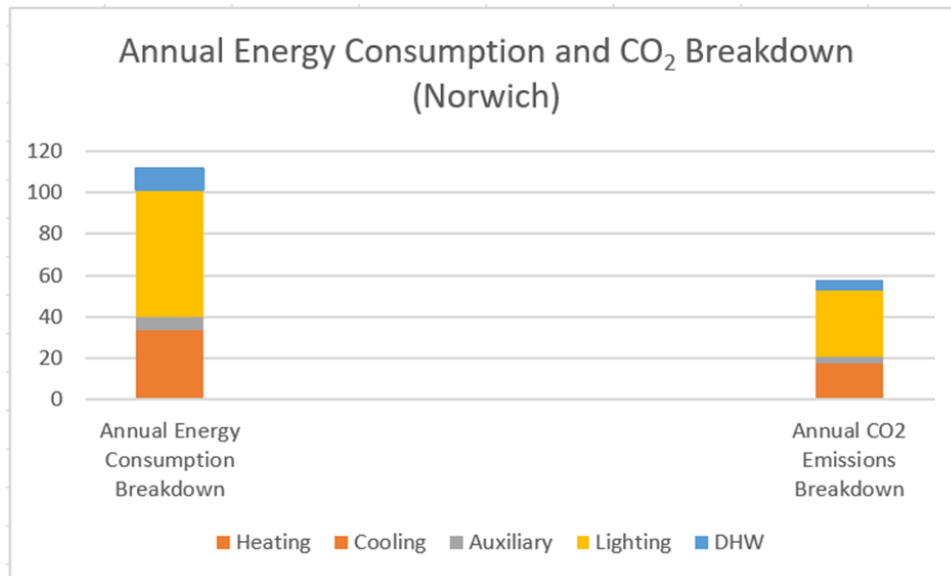

Figure 25. Annual Energy Consumption and CO₂ Breakdown.

The annual energy consumption and CO₂ emissions breakdown of the baseline building modelled in Southampton is presented in Figure 37.

The total annual energy for the current weather scenario for a typical supermarket building in Norwich comes up to 111.75 kWh/m². The emissions are 58.0 kgCO₂/m², with heating and cooling at 0.29 and 33.10 kWh/m², respectively.

5.4.4.2 Future weather scenarios

Under the future weather files of the 2050s and 2080s with their various emission scenarios, simulations are conducted to see the difference in the supermarket model's energy, emissions, heating, and cooling.

There are six and nine emissions scenarios under the 2050s and 2080s, respectively, provided by CIBSE. In addition, several simulations were run and validated to determine the percentage increase/decrease for the key performance indicators.

5.4.4.3 Energy & CO₂ emissions

Figure 38 shows the annual energy and carbon dioxide consumption for future climatic projections for the 2050s period, medium and high emission scenarios, and 10th, 50th, and 90th percentiles. Similarly, for the 2080s period, the figure provides the energy and emissions consumption for the three emission scenarios low, medium, and high. All the predicted scenarios show a constant gradual increase in energy consumption over the years, irrespective of any scenario or percentile that was chosen.

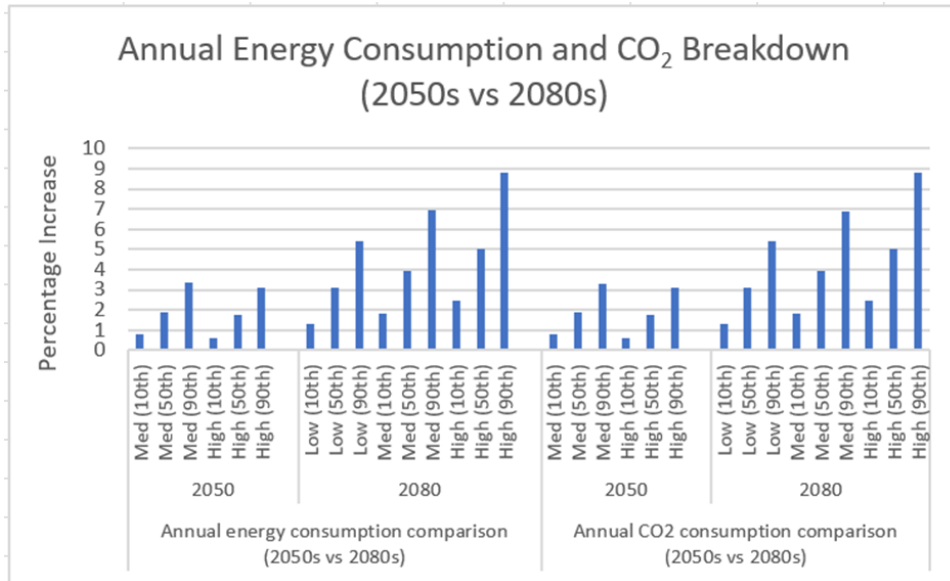

Figure 26. Annual energy and CO₂ consumption comparison (the 2050s vs 2080s).

For energy consumption, the trend is observed in all the emission scenarios, with a peak increase of 3.33% in the 2050s medium (90th) percentile scenario and an 8.80% increase in the 2080s high (90th) percentile scenario, respectively.

For carbon emissions, the trend is observed in all the emission scenarios, with a peak increase of 3.32% in the 2050s medium (90th) percentile scenario and an 8.79% increase in the 2080s high (90th) percentile scenario, respectively.

The increased consumption over the years is attributed to the increased cooling demand in the face of increasing climatic temperature.

5.4.4.4 Heating & Cooling comparison

Figure 39 shows the annual heating and cooling energy comparison for future climatic projections for the 2050s period, medium and high emission scenarios, and 10th, 50th, and 90th percentiles. Similarly, for the 2080s period, the figure provides the heating and cooling energy consumption for the low, medium, and high emission scenarios.

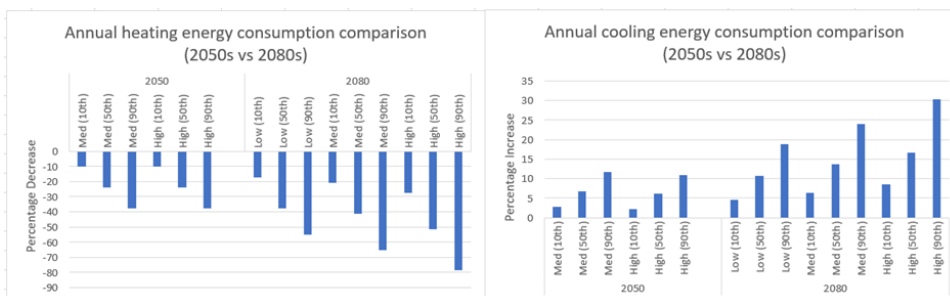

Figure 27. Annual energy and CO₂ consumption comparison (the 2050s vs 2080s).

No matter whichever scenario or percentile is selected, every forecasted scenario for heating energy gradually decreases over time, while every predicted scenario for cooling energy demonstrates a rise.

For heating energy, the trend is observed in all the emission scenarios, with a peak reduction of 37.93% in the 2050s medium (90th) percentile/high (90th) percentile scenario and a 78.56% reduction in the 2080s high (90th) percentile scenario, respectively. It shows a gradual decrease in the temperature over time. The reduced heating consumption over the years is attributed to the increase in climatic temperature, influencing the heating demand to be minimised.

For cooling energy, the trend is observed in all the emission scenarios, with a peak increase of 11.6% in the 2050s medium (90th) percentile scenario and a 30.36% increase in the 2080s high (90th) percentile scenario, respectively. This rise in the annual cooling energy consumption shows a gradual increase in the temperature over time. Therefore, over the years, the increased cooling consumption has been attributed to the increasing external temperature, thus increasing the need for cooling in supermarket buildings.

5.4.5 Full Multi-city Comparative Analysis

Tables 23 a-d present all the key performance indicators data of a typical supermarket building for London, Manchester, Southampton, and Norwich.

It includes the energy consumption, annual carbon emissions, heating, and cooling energy consumption for the future years of the 2050s and 2080s emission scenarios of a low, medium, high and 10th, 50th and 90th percentile, respectively.

The tables represent the differences between the various cities and the emission scenarios. It also helps distinguishes the best- and worst-case scenarios among all possible outcomes.

Table 23a. Multi-city annual heating consumption (all emissions scenarios).

Annual heating consumption	London	Manchester	Southampton	Norwich
2050				
Med 10	-14.29	-10.71	-9.09	-10.34
Med 50	-28.57	-25.00	-27.27	-24.13
Med 90	-47.62	-39.29	-40.91	-37.93
High 10	-14.29	-10.71	-9.09	-10.34
High 50	-28.57	-25.00	-27.27	-24.13
High 90	-47.62	-39.29	-40.91	-37.93
2080				
Low 10	-23.81	-17.86	-18.18	-17.24
Low 50	-42.86	-39.29	-40.91	-37.93
Low 90	-66.67	-57.14	-59.09	-55.17
Med 10	-23.81	-21.43	-22.72	-20.69
Med 50	-52.38	-42.86	-45.45	-41.38
Med 90	-76.19	-67.86	-68.18	-65.51
High 10	-33.33	-28.57	-31.81	-27.58
High 50	-61.90	-53.57	-54.54	-51.72
High 90	-85.71	-75.00	-72.72	-78.56

Table 23a shows the future climatic projections for the 2050s period, medium and high emission scenarios, and 10th, 50th, and 90th percentiles. Similarly, for the 2080s period, they provide the heating consumption for the low, medium, and high emission scenarios. All the

predicted scenarios show a constant decrease in heating consumption over the years, irrespective of any scenario or percentile that was chosen.

Under the 2050s at medium and high (90th) scenario, London has the highest decrease of 47.62%, whereas Manchester has a reduction of 39.29%. Southampton's peak decreased by 40.91%, and Norwich dropped to 37.93% of its current value.

Under the 2080s at the high (90th) scenario, London has the highest decrease of 85.71%, whereas Manchester has a reduction of 75.00%. Southampton's peak decreased by 72.72%, and Norwich dropped to 78.56% of its current value.

The significant decline in heating requirements indicates a rapid increment in temperatures in the future across the UK.

Table 23b. Multi-city annual cooling consumption (all emissions scenarios).

Annual cooling consumption	London	Manchester	Southampton	Norwich
2050				
Med 10	2.93	2.5	3.14	2.74
Med 50	7.14	6.23	7.35	6.64
Med 90	12.47	11.00	12.91	11.6
High 10	2.31	1.72	2.32	2.2
High 50	6.58	5.58	6.53	6.16
High 90	11.46	10.16	11.61	10.87
2080				
Low 10	4.98	4.15	5.44	4.62
Low 50	11.52	10.03	11.95	10.72
Low 90	20.02	17.85	20.93	18.76
Med 10	6.93	6.07	7.59	6.43
Med 50	14.75	13.21	15.73	13.71
Med 90	25.65	23.36	27.08	23.95
High 10	9.06	8.05	10.16	8.43
High 50	18.72	16.97	20.09	16.55
High 90	32.41	30.11	34.43	30.36

Table 23b shows the future climatic projections for the 2050s period, medium and high emission scenarios, and 10th, 50th, and 90th percentiles. Similarly, for the 2080s period, they provide the cooling consumption for the low, medium and high emission scenarios. All the predicted scenarios show a constant increase in heating consumption over the years, irrespective of any scenario or percentile that was chosen.

Under the 2050s at medium (90th) scenario, London has the highest increase of 12.47%, whereas Manchester has risen 11.00%. Southampton has a peak increase of 12.91%, and Norwich has grown to 11.60% of its current value.

Under the 2080s at the high (90th) scenario, London has the highest increase of 32.41%, whereas Manchester has risen to 30.11%. Southampton peaked at 34.43%, and Norwich increased to 30.36% of its current value.

This increase in cooling requirements can be attributed to the long summers and harsh summer waves, which can be predicted due to increasing annual average temperature and a rapid rise in seasonal peaks in summers.

Table 23c. Multi-city annual total energy consumption (all emissions scenarios).

Annual total energy consumption	London	Manchester	Southampton	Norwich
2050				
Med 10	0.85	0.69	0.9	0.78
Med 50	2.08	1.7	2.12	1.9
Med 90	3.66	3.00	3.73	3.33
High 10	0.67	0.47	0.67	0.62
High 50	1.92	1.52	1.88	1.76
High 90	3.36	2.77	3.36	3.12
2080				
Low 10	1.45	1.13	1.56	1.32
Low 50	3.37	2.73	3.45	3.08
Low 90	5.89	4.88	6.08	5.4
Med 10	2.04	1.66	2.19	1.84
Med 50	4.34	3.62	4.57	3.94
Med 90	7.57	6.41	7.88	6.92
High 10	2.67	2.20	2.94	2.43
High 50	5.51	4.65	5.84	5.04
High 90	9.58	8.30	10.04	8.8

Table 23c shows the future climatic projections for the 2050s period, medium and high emission scenarios, and 10th, 50th, and 90th percentiles. Similarly, for the 2080s period, they provide the cooling consumption for the low, medium and high emission scenarios. All the predicted scenarios show a constant increase in energy consumption over the years, irrespective of any scenario or percentile that was chosen.

Under the 2050s at medium (90th) scenario, London has the highest increase of 3.66%, whereas Manchester has risen 3.00%. Southampton has a peak increase of 3.73%, and Norwich has grown to 3.33% of its current value.

Under the 2080s at the high (90th) scenario, London has the highest increase of 09.58%, whereas Manchester has risen to 8.30%. Southampton peaked at 10.04%, and Norwich increased to 8.80% of its current value.

This increase in cooling requirements can be attributed to the burden on cooling requirements.

Table 23d. Multi-city annual carbon dioxide emissions (all emissions scenarios).

Annual carbon dioxide emissions	London	Manchester	Southampton	Norwich
2050				
Med 10	0.86	0.67	0.89	0.77
Med 50	2.09	1.69	2.12	1.89
Med 90	3.65	2.99	3.72	3.32
High 10	0.67	0.46	0.65	0.62
High 50	1.92	1.50	1.88	1.76
High 90	6.45	2.76	3.35	3.12
2080				
Low 10	1.46	1.13	1.55	1.32
Low 50	3.38	2.73	3.45	3.08
Low 90	5.88	4.80	6.07	5.41
Med 10	2.04	1.65	2.19	1.84
Med 50	4.34	3.61	4.55	3.95
Med 90	7.56	6.41	7.87	6.91
High 10	2.66	2.20	2.93	2.43
High 50	5.51	4.63	5.83	5.03
High 90	9.59	8.29	10.02	8.79

Table 23d shows the future climatic projections for the 2050s period, medium and high emission scenarios, and 10th, 50th, and 90th percentiles. Similarly, for the 2080s period, they provide the cooling consumption for the low, medium and high emission scenarios. All the predicted scenarios show a constant increase in carbon dioxide emissions over the years, irrespective of any scenario or percentile that was chosen.

Under the 2050s at the high (90th) scenario, London has the highest increase of 6.45%, whereas Manchester has risen 2.76%. Southampton has a peak increase of 3.35%, and Norwich has grown to 3.12% of its current value.

Under the 2080s at the high (90th) scenario, London has the highest increase of 09.59%, whereas Manchester has risen to 8.29%. Southampton has a peak increase of 10.02%, and Norwich increased to 8.79% of its current value.

Emission patterns are congruent with energy patterns with London, Manchester, Southampton, and Norwich in inclining order for both energy consumption and emissions.

5.4 Conclusion & Discussion of the Chapter

The study investigated the variability of future climatic conditions in a typical UK supermarket across four different cities – London, Manchester, Southampton, and Norwich. The analysis of simulation results leads to the prediction of a consistent inclination of annual building energy consumption, building emission rate, annual building electricity consumption, cooling demand, and a declining trend in heating demand over the different timelines of the 2050s and the 2080s.

Regarding the total energy consumption difference between current and future data sets, the peak percentage was observed to be 3.66%, 3.00%, 3.73% and 3.33% for London, Manchester,

Southampton, and Norwich, respectively, when considered for the 2050s medium (90th) percentile. Similarly, for the 2080s high (90th) percentile, the peak increases were 9.58%, 8.30%, 10.04% and 8.80%, respectively, for the four cities. The peak differences in emissions were found to be 6.45%, 2.76%, 3.35% and 3.12% when observing the 2050s high (90th) percentile, whereas the same was 9.59%, 8.29%, 10.02% and 8.79% for the 2080s high (90th) percentile for the four urban settlements respectively. The cooling and heating energy analysis for current weather and future projections identifies the most drastic effect of temperature on the overall consumption in the supermarkets in London, Manchester, Southampton, and Norwich. For cooling, these values were 12.47%, 11.00%, 12.91% and 11.60% for 2050s medium (90th) percentile and 32.41%, 30.11%, 34.43% and 30.36% for 2080s high (90th) percentile respectively. The differences in heating parameters were 47.2%, 39.29%, 40.91% and 37.93% for 2050s medium as well as high (90th) percentile, and for the 2080s high (90th) percentile, the difference in the indicators turned out to be 85.71%, 75.00%, 72.72% and 78.56%.

It can be said that for energy consumption and carbon dioxide emissions, London, and Southampton both exhibit higher inclinations than Manchester and Norwich. Southampton displays the highest deviations concerning current emission indicators. In terms of changes in values of heating, London depicts the highest magnitude. Empirical observations related to Manchester can also lead one to conclude that in terms of total energy consumption demand, CO₂ emissions and cooling (for both 2050s and 2080s datasets) and heating (in 2050s), the city's parameters show the slightest variations. Thus, Norwich, with moderate percentage differences between current and future climatic predictions across all the four significant parameters – total energy consumption, carbon emissions, heating and cooling tends to form a bridge between London and Southampton on the higher side and Manchester the lower side. Regional analysis shows that the southern cities face higher variations than their northern counterparts, with Manchester being the northernmost among the cities with the least contrast.

All these variations are congruent with the scope of annual average thermal change predicted by the general circulation model based on the IPCC scenarios, which generally display increasing temperatures over time. The study, therefore, establishes the significance of the variability of climatic patterns on a supermarket's building performance, considering the future timelines that are also directly related to the life span of the building observed across four regional settlements. It further proves correct the hypothesis that an increase in energy used for cooling and emissions coupled with the reduction in heating demand will be inevitable with rising temperatures. This work has shown that simulations with future climatic projections can mitigate the environmental implications to the manufactured urban ecosystem. It could significantly assist the architects and engineers in conceptualising and formulating feasible solutions to the challenges posed by the gradual increment in climatic extremities.

Conscious policymaking and a dedicated strategy with the institutional, economic, political, and social framework can help the buildings and structures to be able to combat climate change. This research enables and empowers the existing scientific inputs to amplify further the predictability and the very implications of any construction-based endeavours undertaken in the future and promote effective, efficient, and responsive eco-friendly policies. It also enables the engineering community to understand the constituents and the requirements related to future-proof supermarket buildings. It would allow the decision-makers to adopt mitigation strategies to slow down the effects of climate change by tackling it beforehand, building a safer, more resilient, and secure world for us all.

The most challenging aspect that can emerge from attempts to fruitfully implement practical policy decisions, as can be derived from the analysis of the data gained through simulations, will be related to a renewed focus on reducing cooling loads and augmenting the efficiency of supermarket buildings. Emerging renewable and microgeneration technologies can adapt to climate change by infusing energy efficiency measures through enhanced effective planning and design options to generate a robust construction blueprint. HVAC systems, passive design technologies to mitigate mechanical ventilation, and better refrigerant usage with low environmental impact and excellent thermodynamic performance can be absorbed and integrated into supermarket architecture and energy designs to reduce future energy demands in supermarkets.

Chapter 6 - A quantitative case study to assess the performance of UK supermarket buildings concerning future climate change and modern construction techniques (MMCs)

6.1 Problem Statement

This study examines several non-domestic building construction techniques and their impact on a typical UK supermarket's building performance under the worst-case climate change scenarios in the 2080s. To determine operating energy consumption and carbon emissions, emphasis is placed primarily on the three LIDL-approved construction techniques and the materials used in their construction. The Chartered Institution of Building Services Engineers (CIBSE) provides the current and projected weather files to be tested. Thermal Analysis Software (TAS), a dynamic building simulation tool, quantifies the results and generates reports. The case study is based on a recently constructed single-story supermarket building in Norwich. It employs three building models, P1, P2, and P3, each using a particular set of construction materials. The results indicate that the percentage increase in energy consumption and carbon emissions for models P1 and P2 is close to 8.80%. However, the P3 model has an increase of less than 8.50% compared to the building's current condition, making it a marginally better option. It suggests that a precast concrete and glulam beam structure offer the best resistance against the worst climate change scenario. While presenting the findings, this investigation merges the two aspects of the built environment, construction and operation.

According to IPCC (The Intergovernmental Panel on Climate Change), climate change is one of the most urgent problems of the 21st century because the global climate is constantly fluctuating. It significantly impacts the environment, particularly the built environment, which influences not just energy use and greenhouse gas (GHG) emissions but also global costs and the economy (Stern & Great Britain. Treasury 2007). One of the major recognised contributors to climate change is the buildings' operational energy (in-use phase) (Sharma et al., 2011; Adalberth, 1997). According to The Non-Domestic National Energy Efficiency Data-Framework 2020 or ND-NEED (England and Wales), there are 1,656,000 non-domestic buildings in England and Wales (end of March 2020). Among them, the top three non-domestic building users are Shops (29%), Offices (20%) and Factories (14%), as depicted in Figure 40.

The most recent data also suggests that total non-domestic buildings in England and Wales used 293 TWh and 140 TWh of electricity, respectively, and 153 TWh of gas (Steadman et al. 2020). Due to such huge energy consumption in the UK, the built environment and energy-intensive buildings are one of the largest sources of emissions. Therefore, it is necessary to quantify and reduce these emissions.

However, recent developments demonstrate the increasing importance of the impact of construction in proportion to operational energy use as well. During the complete life cycle of

the building, the operational energy plays a significant part as it is responsible for the building equipment usage such as the lighting, cooling, heating, use of domestic hot water and other minor appliances (Hasan et al. 2020). However, it is also interlinked with other stages, including construction, occupation, and end-of-life deconstruction. In recent years, there has been much focus on the overall life cycle of the building, which includes embodied (production/construction and end-of-life) and operational (in-use) stages.

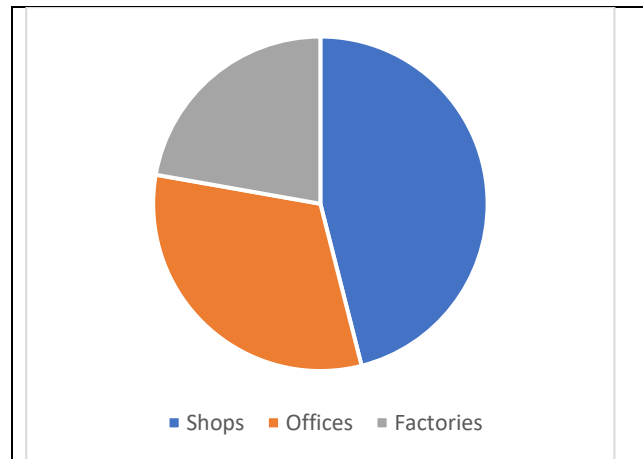

Figure 28: Energy usage division by percentage in the UK non-domestic buildings (Steadman et al. 2020).

6.2 Relationship Between Modern Construction Materials/Methods and Climate Change

As previously mentioned, much emphasis has been placed on reducing and saving on the costs of the buildings in the operation phase as well as their emissions and energy consumption. Nevertheless, adaptation planning for the overall reduction is needed by considering the building materials utilised in the structure of the building. Different buildings in the UK are constructed to last only for a specific period, usually a few decades. For example, the service life of a UK residential house is assumed to be 50 to 60 years for international assessments (Meikle and Connaughton, 1994).

It is important to consider how the building's performance is affected by the link between the materials used in construction and the effects of climate change. Such an approach is necessary since there is a significant likelihood that future performance issues may not exist in the buildings' present state. (Almås et al. 2011). Ultimately, it will shorten the building service life (El-Dash 2011). Therefore, it has become a significant challenge in the UK to develop innovative construction methods using different building materials for the newly built supermarket and retail buildings that will not only be able to provide the building with futureproofing by reducing the impact of future climate change but also prolong the service life of the building and keep the carbon emissions and energy consumption of the building in check, especially in the face of changing climate under various representative concentration pathway scenarios (RCPs).

Typically, the selection of building materials is based on providing a high comfort level to the customers by achieving a particular internal environment that would enable the supermarket to function efficiently. There is no regard given to the external climate.

According to one study, there are three important aspects to selecting a specific construction method to ensure good performance of the building (Phillipson, Emmanuel & Baker 2016). They include:

1. Protecting the building and its contents against climate loads.
2. Maintaining good performance in the face of weathering and other degradation mechanisms.
3. Allowing ventilation to control internal temperatures, moisture levels, and air quality.

It is also important to note that historically speaking, some buildings, specifically high energy use intensity (EUI) ones, such as supermarkets and retail stores, have been designed and constructed using historical climatic data as compared to other domestic buildings such as homes/dwellings (Bahadori-Jahromi et al. 2022). The idea behind such construction was to perform a risk evaluation of the excesses that a building might experience from the climate loadings. However, as the recent extreme climate change has proved, this approach is inadequate, and designers are now encouraged to consider future climate change instead (Stalker, 2006).

Even though the relationship between construction methods and climate change is complex, it cannot be ignored. It is currently a critical factor to consider while designing a building. Multiple studies indicate that, during the construction stage of the building, focusing only on the previous climate data or ignoring the future climate change data can have a potentially catastrophic impact on the built environment, including the risk of flooding in some cases (Milly et al. 2002; Wilson & Piper 2008).

6.3. Methodology

The methodology followed for this work consists of two different aspects of the investigation, and the latter combination is used to bring forth comprehensive results. It includes using different construction methods (LIDL-approved ones) and building services to quantify operational usage and emissions of the supermarket building.

6.3.1 LIDL-approved construction methods

The first part of the research approach ensures that LIDL, a leading supermarket retail chain in the UK, approves the construction methods used in this paper. Each construction method uses a different set of construction materials which is then used to change the building fabric accordingly. For the analysis, building energy modelling software is required, allowing the user to incorporate multiple building construction materials and accommodate the operational energy and carbon emissions functionality needs. The software model must also allow the use of climate change scenario data (current and future). Using such software facilitates the generation of accurate results for the current state of the climate in a particular location. It generates results for the supermarket building for the future years.

6.3.2 Thermal Analysis Software (TAS) v9.5.0- Building Energy Modelling:

TAS offered by EDSL meets all the requirements needed to quantify and report the results in the present study. It is a complete dynamic building simulation package. Some of the important characteristics of TAS are described below:

- 3D Modeller: Able to generate building models, simulate the models, and perform detailed daylight analysis.
- Building Simulator: Capable of editing specific aspects before simulation of the building, such as apertures, internal gains, and constructions, along with providing 3D visualisation and multiple databases to use, such as calendar, construction, and internal conditions databases. It also assists with overheating analysis, calculating heating, and cooling loads, calculating air flows, etc.
- Results viewer: This characteristic helps in viewing and exporting the data (2D, 3D hourly results) in tabular form and generating reports and charts for easy reading.

The construction materials are assigned individually to each of the elements used in building construction and are tailored to the specifications of a typical supermarket. The simulation starts with choosing a specific building and its local climate modelling. For the basic components of the building, such as the floor, walls, windows, and doors, it is important to import the building's Computer Aided Design (CAD). The next step involves drawing the physical walls, assigning building elements and adding other windows and zones. The final step is to run the simulation and check for errors. If any are found, fix the theme, and run the final modelling file (Hasan et al. 2022).

6.3.3 Construction Database – TAS EDSL

The construction database application (TCD) available in TAS consists of multiple construction-related databases which assist the building simulator in modelling the conduction of heat transfer and storage through the fabric of the building. The supermarket building fabric is composed of material layers, and the building simulation models the interaction of heat flow through each of these layers individually. The main construction database in TAS v9.5.0 uses ASHRAE (The American Society of Heating, Refrigerating and Air-Conditioning Engineers) v90.1 standards (2007, 2010, 2013 and 2016).

6.3.4 3D Modeller and Building Design

Since the supermarket building needs to be assessed for its operational needs, it is important that initially, a 3D model of the building is designed. The 3D design, along with the important characteristics of the building, such as height, structure/frame, floor area, entrance lobby, and other rooms/offices, are simulated with the help of an AutoCAD diagram. The operational hour of the supermarket is calculated using the National Calculation Methodology (NCM) standard calendar. As each room/office is designed according to a typical supermarket in the UK, it is noted that each room is allocated with its respective zone in the software with a specific set of internal conditions adhering to the NCM.

CIBSE (The Chartered Institution of Building Services Engineers) Weather Files (Current and Future)

An important aspect of this investigation is to explore the impact of future climate change on different building fabrics and the building services of the supermarket building for the future. However, it is necessary first to evaluate the demand (cooling, heating) of the building in today's local climate so that it can be compared to the future needs of the building. TAS allows incorporating the weather files provided by CIBSE and generates hourly dynamic simulations with the current and future weather files.

The weather data used for energy analysis and compliance with the UK Building Regulations (Part L) is known as Test Reference Year (TRY). It comprises 12 separate months of data, each representing an 'average' month as derived from the collected data (Herrera et al. 2017). CIBSE licenses the historical weather data from the Met (The Meteorological Office) for 16 locations across the UK, three of which are in London.

CIBSE also provides the emission scenarios for the future, which are described as follows:

The 2050s (2041-2070)

High - 10th, 50th, 90th percentile

Medium - 10th, 50th, 90th percentile

The 2080s (2071-2100)

High - 10th, 50th, 90th percentile

Medium - 10th, 50th, 90th percentile

Low - 10th, 50th, 90th percentile.

6.4 Case Study

The study considers three approved construction techniques for a standard design LIDL supermarket building. Some of the specifics of the LIDL building design, which extends to most of the standard retail buildings in the UK, include a floor area of 2,500 m² single story building with multiple offices and rooms each, with their own energy usage and construction methodology.

The three approved methods of construction for the building fabric used mainly in retail and supermarket constructions in the UK (P1 – P3) are given below:

1. Model P1: Steel columns, structural beam frame, cladding panel external walls, and concrete slab foundation.
2. Model P2: Steel columns, structural beam frame, Proton block, and cladding panel external walls with a concrete slab foundation.
3. Model P3: Precast concrete column and glulam beam structural frame, precast concrete, and cladding panel external walls with a concrete slab foundation.

Other important parameters regarding the building fabric and aesthetics include the internal walls finish for each model to have the paint to plasterboard. The floor should be covered in ceramic tiles, vinyl, and paint. There is a curtain walling on one side of the building with aluminium frames with external steel doors. Some of the details of the models are given in Table 24, which explains the models with the construction details, such as the building fabric (construction materials), together with the pictorial description of the models designed in the Autodesk Revit software.

6.4.1 Selection of City

For the present study, the city of Norwich, the largest city in East Anglia, is selected, situated in the climatic region of Eastern England. Norwich has long, extremely cold, and windy winters, while the summers are short, comfortable, and partly cloudy. The research work that provides insight into the effect of climatic changes on retail buildings in Norwich, UK, is very limited.

CIBSE provides weather data for 16 locations in the UK for the current and future periods. This research at Norwich is necessary to stay ahead of the climate change curve because it is extremely unlikely that the rise in the mean summer temperature for the South and East of England will be below 1.4 °C by the 2080s in the United Kingdom. (Gupta & Gregg, 2012).

6.4.2 Building Modelling and Simulation

All the data used for modelling purposes is collected by conducting site visits to the LIDL stores and undertaking buildings' architectural design files. The data is verified thoroughly for accuracy. Some of the important information collected includes the building's construction, such as construction material with their thermal transmittance or U-values, thermal zones, and building services with their fuel types for the heating, cooling, ventilation, hot water, and lighting, based on the EPBD (Energy performance of buildings directive) requirements.

Table 24. Approved design models of different construction methods.

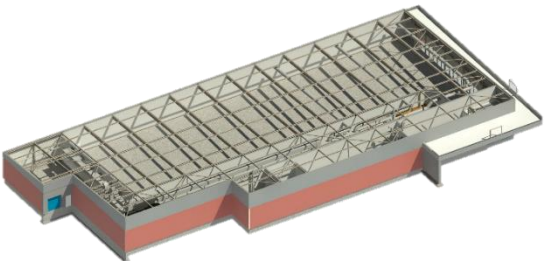
Model	Construction Details (Building Fabric)	Illustrated Description
P1	<ul style="list-style-type: none"> • Cladding panel • external walls • Steel columns • Steel beams Slab foundation	
P2	<ul style="list-style-type: none"> • Poroton block + Cladding panel • external walls • Steel columns • Steel beams • Slab foundation 	

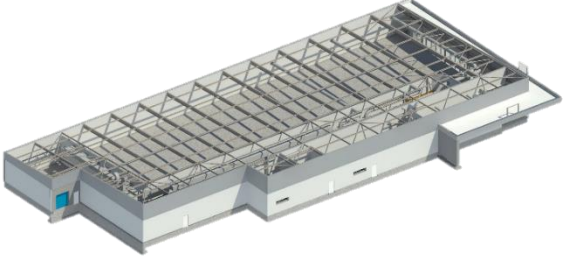
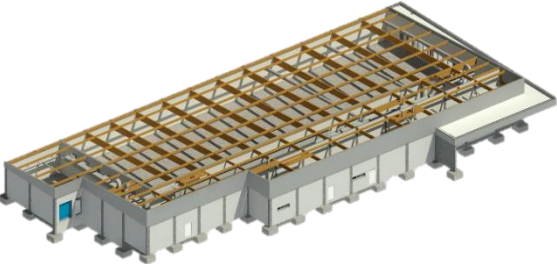
		
P3	<ul style="list-style-type: none"> • Precast concrete + Cladding panel external walls • Precast concrete columns • Glulam beams • Slab foundation 	

6.5 Results and Discussion:

The first part of the results includes the annual energy consumption and the annual carbon emissions for a typical UK supermarket building for all three approved construction methods under the current scenario of the local climate of Norwich.

1. **Current Scenario:** Under the current scenario, the 2020s timeline in CIBSE weather datasets, the results of each model P1, P2, and P3 are summarised in Figure 41.

For P1 and P2, the total annual energy consumption is 111.75 KWh/m², and the carbon emissions value is 58.0 KgCO₂/m². For model P3, the total annual energy consumption is 110.94 KWh/m², and the carbon emissions are 57.6 KgCO₂/m². Survey data and real-time annual energy measurements recorded over five consecutive years showed a consumption range of 137.31 KWh/m² to 150.53 KWh/m². These values are slightly higher than the 111.75 KWh/m² calculated using TAS. However, these differences are affected by various factors such as the exact location of the building, weather database difference and historical climate change, dissimilar HVAC systems, air infiltration systems, as well as the use of TAS instead of Simplified Building Energy Model (SBEM) methodology carried out by independent commercial assessors.

Models P1 and P2 present almost identical results for both the annual energy consumption and the carbon emissions, whereas P3 has a slight decrease in both attributes. It is understandable as glulam laminated timber beams would produce fewer emissions than their counterparts.

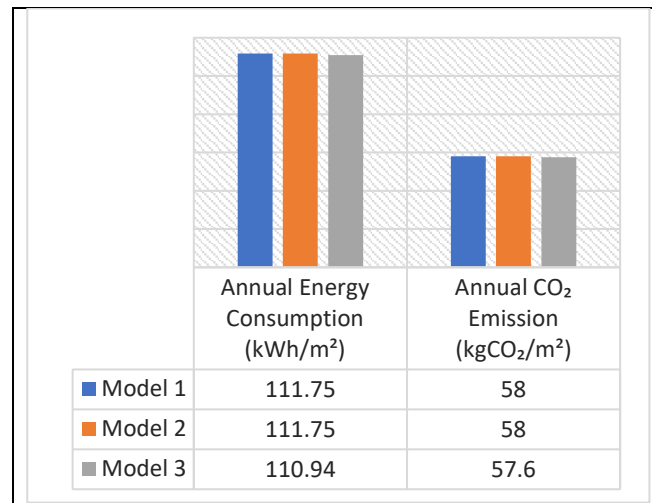

Figure 29: Model P1, P2 and P3 - Operational Energy/Carbon emissions under current scenario.

2. Future Worst-Case Scenario

The building service life is the time during which the building is in use. Multiple studies have indicated that the average service life of a commercial building varies from 50 to 75 years (Junnila & Horvath 2003; Scheuer, Keoleian & Reppe 2003). All the future calculations are performed using the CIBSE weather files of the 2080s with the emissions scenarios of ‘High’ 10th, 50th and 90th percentile considered.

3. The high 2080s (2071-2100 years)

The year the 2080s will cover thirty years from 2071 to 2100 years. CIBSE offers three emission scenarios for the 2080s, which are Low, Medium, and High. Since this investigation is to test the supermarket building under the future worst-case scenario, the focus will be only on the High emission scenario of the 10th, 50th, and 90th percentile for each of the three approved construction methods.

4. High 10th Percentile

The 10th percentile of the High emission scenario shows the likely minimum change (unlikely to be less than) with current theories and models (Eames, Kershaw & Coley 2010). The annual energy consumption and carbon emission of each of the three models are summarised in Figure 42, where Model P1 and P2 have almost identical values of 114.47 KWh/m² and 114.46 KWh/m² for annual energy consumption and the same value of 59.40 KgCO₂/m² for carbon emission. Model P3 slightly reduces both parameters with 113.74 KWh/m² and 59 KgCO₂/m², respectively.

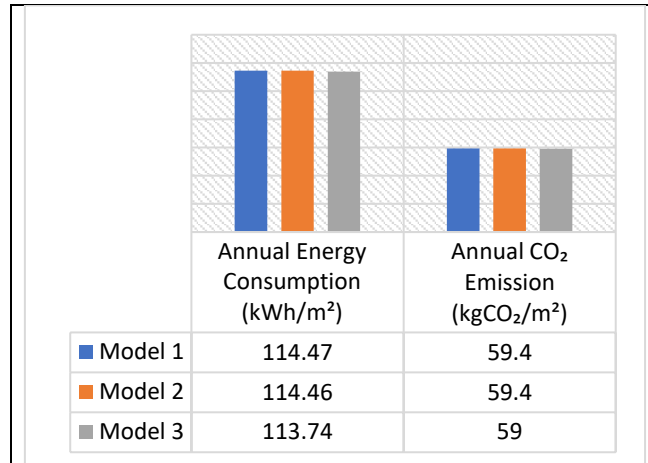

Figure 30: Model P1, P2 and P3 - Operational Energy/Carbon emissions under High 10th percentile.

5. High 50th Percentile:

The High 50th percentile is the central estimate between the emissions scenario's 10th and 90th percentile, and the results are compiled in Figure 43. The two parameter values for Model P1 and P2 are almost identical, with 117.38 KWh/m² and 117.37 KWh/m² for annual energy consumption, respectively and 60.90 KgCO₂/m² for carbon emissions. As expected, Model P3 has performed slightly better with 116.81 KWh/m² and 60.60 KgCO₂/m², respectively.

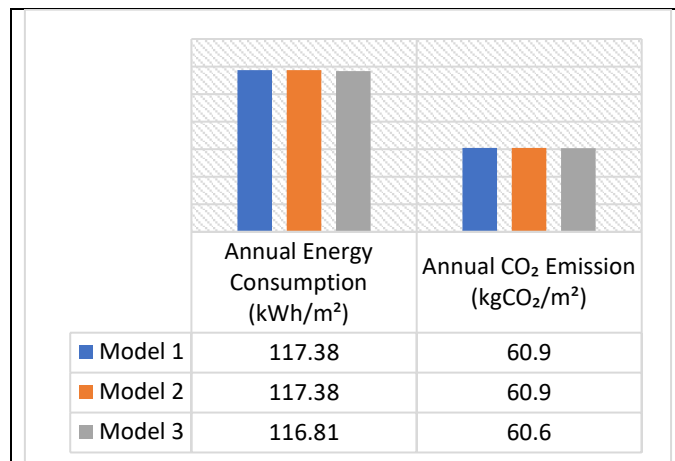

Figure 31: Model P1, P2 and P3 - Operational energy/Carbon emissions under High 50th.

6. High 90th Percentile:

Using a high percentile TRY such as the 90th indicates the extent of likely future warming (UKCP09 defined the 90th percentile as unlikely to be greater than).

Under the worst-case scenario and 90th high percentile, the annual energy consumption of Models P1 and P2 reached 121.59 KWh/m² and 121.58 KWh/m² and carbon emissions for both reached 63.10 KgCO₂/m². Figure 44 illustrates how Model P3 performs considerably better with 121.23 KWh/m² and 62.90 KgCO₂/m², respectively.

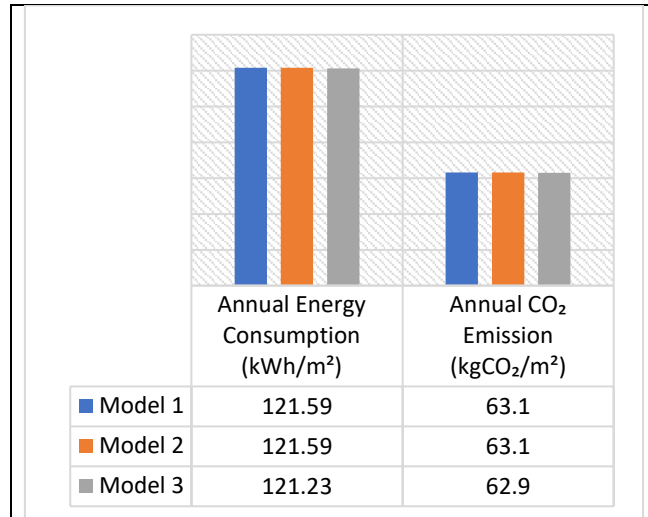

Figure 32: Model P1, P2 and P3 - Operational Energy/Carbon emissions under High 90th scenario.

Figure 45 represents all the possible scenarios with the present (the 2020s) against the future high emission scenarios (10th, 50th and 90th). Under the worst-case scenario of the High 90th percentile emission scenario, the annual energy consumption and carbon emission for the three models increase by the following:

Model P1: Annual energy increase 8.81%, annual carbon emission increases 8.79%

Model P2: Annual energy increase 8.80%, annual carbon emission increases 8.79%

Model P3: Annual energy increase 8.48%, annual carbon emission increases 8.44%

For both the annual energy consumption and annual carbon emissions, the high 90th percentile scenario is catastrophic. Model P1 is the poorest design among the three approved construction methods, especially under future climate change, followed by model P2. Model P3 presents the best option, producing the least carbon emissions. Under the other emission scenarios of the 10th and 50th percentile, a similar pattern can be observed, with P3 performing marginally better than the other two construction techniques. It is important to remember that the resultant values are produced over 60 years with the CIBSE-based emission scenarios based on the original IPCC scenarios.

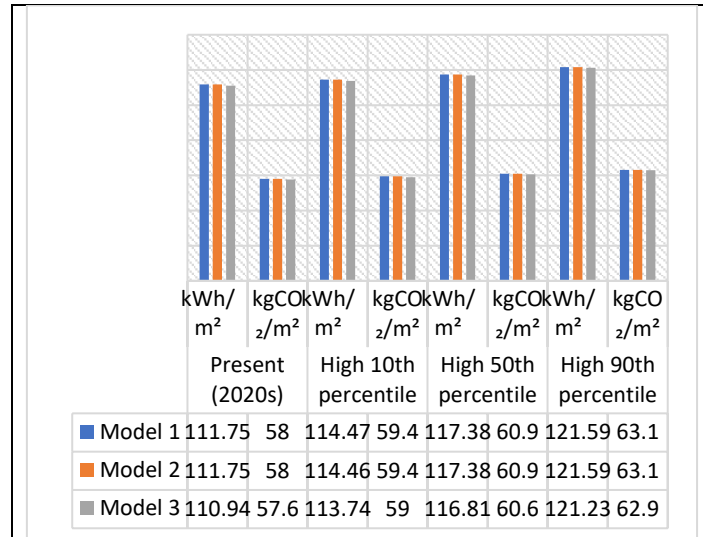

Figure 33: Model P1, P2 and P3 - Operational Energy (KWh/m²)/Carbon emissions (KgCO₂/m²) under all possible scenarios.

6.6 Conclusions and Future Scope

This investigation aimed to design and quantify the impact of future climate change relative to the present day on three different approved construction methods for a typical UK supermarket. Since the major share of the carbon emissions from a building is during its operational phase, the study focused mainly on the in-use phase of the supermarket by focusing on the energy consumption of the building services especially cooling, DHW (domestic hot water), lighting, HVAC (Heating, ventilation, and air conditioning) and AHU (Air handling units) equipment.

A case study of a typical supermarket store with a floor area of 2,500 m² was chosen in Norwich. The building was designed using two different software, Autodesk Revit software and TAS-EDSL, helping to design the different modern construction methods and simulate the operation of building services under different future climatic scenarios, respectively.

The overall investigation thoroughly compares design options with each approved list of methods, including the associated energy consumption and emission scenarios from an operational point of view. This paper gives an important insight into the importance of choosing the right materials as it can substantially reduce GHG (greenhouse gas) emissions by carefully considering the construction method in the future.

The results of models P1 and P2 are almost identical due to the similar U-values of the materials used in their respective construction materials. As the climate keeps changing, the U-value representing the transfer rate of heat transfer through the structure keeps constant, producing identical results. However, the model P3 presents results different from the other two models signifying that the associated carbon emissions and energy usage of the construction materials are better for the environment. It can be concluded that it is the best model out of the three models.

Furthermore, an understanding of how anthropogenic activities can further worsen the environment and their lasting effect on the built environment can be observed with the provided tables and numbers in the study.

The outcomes of this research can influence the policy and decision makers as the EUI buildings, such as supermarkets, are an ever-growing industry in the retail sector. In recent years, the UK, and the EU (Europe Union) have taken bold steps toward decarbonisation and net-zero emissions. This study provides exact figures and statistics to assist the constructors, developers, and institutions lower carbon emissions associated with the new building stock.

Developing the proper design and bold decisions for new buildings would result in a comprehensive carbon emissions reduction strategy that will provide the much-needed futureproofing of the buildings, making them resilient against the inevitable climate change of the future. Further, the study can be extended using the four RCP climate change scenarios and other building construction models. It will better understand all types of buildings apart from supermarket buildings in a particular locality considered for the analysis.

Chapter 7- Reaching the nearly zero energy (nZEB) target: Impact of Energy efficient measures (EEMs) on the operational performance of a newly built London supermarket

7.1 Problem statement.

The newly built buildings, especially supermarkets, are energy-intensive units. All commercial buildings in Europe are to be made to nearly zero energy (nZEBs), according to the Energy Performance Building Directive (EPBD), as the devastating effects of climate change continue to threaten the built environment in Europe. However, there is a lack of information regarding the definition and numerical nZEB specifically as each country continues to make its own definition. There is limited literature available on climate change and its effect on commercial buildings of supermarkets in the UK as it was imagined the cold weather would provide futureproofing of the buildings from climate change effects; however, recent years have proved that nZEB is the next step in providing safety and assurance to the energy-intensive commercial buildings. This study will use the EU Zebra2020 tool to incorporate UK nZEB building targets to achieve a nearly zero energy level for a UK supermarket building which can then be applied to any supermarket or commercial building in the world given its geographical location and the local weather files. The analysis will be done using a 3-D building modelling and simulation software called EDSL Thermal Analysis Simulation (TAS), which uses 3-D computer-aided drawings (CAD) of a typical London supermarket, and it will use the local current weather files of London provided by The Chartered Institution of Building Services Engineers (CIBSE). To ensure all the data is verified and validated, it is tested against the real-time data observed from the supermarket chain of LIDL in the UK to ensure accuracy and eliminate any possible errors. The goal is to assess the potential of implementing energy efficient measures (EEMs) and their contribution to reducing primary energy consumption (PEC) and total carbon emissions in a supermarket building while it is operational. The results show that even though newly built supermarkets are constructed with the latest energy-saving techniques pre-installed, there is still room for improvement and measures that can assist in reaching the nZEB target. Out of these, using a microgeneration/renewable technology such as solar panels or Combined Cooling, Heat and Power (CCHP) along with other minor but effective energy efficiency techniques can provide the biggest change where each of them contributes to lowering the energy as well as carbon emissions of the supermarket building. It is observed that an overall decrease of up to 45% can be obtained with a combination of best EEMs while ensuring the building follows UK's latest building regulations. Notably, this research paves a path for the supermarket building to reach the desired nZEB targets for the UK; the same could be applied to other European nations with a similar strategy. The combination of different EEM selections has been useful to the research, which expands upon the fact that important initiatives should be taken besides investigating renewable technology to lower the PEC. A more detail-oriented exploration of renewable technologies may help better reduce the supermarket's and other commercial buildings' energy consumption and total emissions.

Keywords: Nearly zero energy buildings, UK supermarket, energy efficiency, carbon emissions, primary energy consumption

7.2 Introduction

Climate change is potentially the greatest global environmental challenge facing humankind now and therefore is increasingly acknowledged by the scientific community worldwide. The building community and researchers are continuously working to develop new approaches and methods to assess and design strategies for building resilience. According to the sixth assessment report of the Inter-Governmental Panel on Climate Change (IPCC), human influence has warmed the atmosphere, ocean, and land. Global warming of 1.5°C and 2°C will be exceeded during the 21st century unless deep reductions in CO₂ and other Greenhouse Gas (GHG) emissions occur in the coming decades (IPCC 2021). Therefore, limiting human-induced global warming to a specific level would require limiting growing CO₂ emissions, reaching at least net zero CO₂ emissions, and strong reductions in other GHG emissions.

The researchers investigating urban carbon emissions have mostly focused on the transport sector consuming fossil fuels, residential property's energy consumption and power generation by GHG (Ito, 2014; Glaeser & Kahn, 2010). However, most of the work is conducted in and around commercial buildings, and a significant amount of spending occurs in structures such as supermarkets. According to an estimate, the UK has over 87,000 supermarkets nationwide (Vasquez-Nicholson 2019). The UK building sector accounts for approximately 3% of the total electricity use, and UK supermarkets and similar organisations are responsible for 1% of the UK GHG emissions (Tassou et al. 211). Hence, it is very important that these supermarkets' energy needs, and carbon emissions are tailored to meet the needs of changing future climate.

The 2010 European Energy Performance Building Directive (EPBD) set out a new law which would require the new and retrofitted commercial buildings to be nearly Zero Energy Buildings (nZEBs) (Economidou et al. 2020). An nZEB is described as a “very high-performance building [where] the nearly zero of energy required should be covered by energy from renewable sources” (Economidou et al. 2020). However, EPBD has provided a very vague definition of nZEB. Due to many reasons, such as variability of the local climate, the advancement of built environment technology, building rules/traditions and the level of ambition of individual states of the EU, the interpretation opens for the member states (Boermans, 2011).

The recent research and literature review show that some work has been done to quantify the high potential energy and cost savings linked with new buildings as well as retrofitting the buildings. Most studies have focused only on retrofitting residential buildings (Asdrubali et al. 2105; Salem et al. 2019). However, the commercial sector consumes significantly larger energy in comparison. As a result, the nZEB residential buildings and houses are being implemented in Europe, whereas the retrofitting and life cycle costs (LCCs) of the commercial sector lacks much major progress (Paoletti et al. 2017)

There need to be active research investigations in the UK regarding a typical UK supermarket being retrofitted to nZEB standards. The methodology of this paper consists of several steps, whereby the first step is to validate the simulation model results with the actual supermarket

store data. It has been noted that the performance gap of such simulation is usually $\pm 30\%$ (Delzendeh et al. 2017; EDSL 2011).

The first step would be to make an accurate model of the supermarket store, and Thermal Analysis Software (TAS) is used for that purpose. The software provides annual energy consumption, primary energy consumption (PEC), annual CO₂ emissions, and other important building performance parameters. The actual building performance data is collected using LIDL stores currently operating in the UK as a part of the site survey investigation and validated against the baseline model. This model is then incorporated with various EEMs and simulated to obtain the best solution. The far-reaching impact of this methodology will enable the researcher and building engineers to replicate and reproduce a cost-effective solution for similar buildings such as retail spaces, warehouses, and office spaces.

7.2.1 Background

Supermarkets are one of the most energy-intensive non-residential buildings, particularly due to their large cooling, heating, and lighting needs. In the UK, the term ‘zero-carbon buildings’ is also used for a building with very efficient energy usage. A significant portion of the building’s energy consumption is fuelled using green renewable energy sources. In most cases, a microgeneration system is very desirable, but it is not always feasible that the building’s energy consumption can only be covered using one system.

Using the individual EEMs and retrofitting the whole building will lower the total annual energy and carbon emissions consumption and offer overall financial savings. When retrofitting buildings, it is important to consider the ‘minimal technical interventions’ (Loli & Bertolin, 2018).

A study from the US about energy efficiency measures of 12 prototypical buildings in 16 cities with three building designs of new commercial buildings suggested that conventional energy efficiency technologies can be used to decrease energy use by 20–30% on average and up to over 40% for some building types and locations. Furthermore, these decreases in energy with the improved efficiencies allow the installation of smaller and cheaper equipment such as the HVAC. Such installations reduce the carbon footprint of the building by 16% on average, saving money and energy. The results lead to several implications of interest to the policy and decision-makers. Investments in building energy efficiency measures recommended by whole building energy simulations are often cost-effective and have competitive annual investment returns (Kneifel 2010).

A similar notion is established from a technical report published by The National Renewable Energy Laboratory (NREL), which simulated the potential to achieve the nZEB standards in commercial buildings in the US. It concluded that with the use of technology and design practices, 62% of buildings and 47% of the floor space could reach those standards along with taking steps such as improving the building envelope, lighting controls, plug and process loads, and HVAC system, decreasing the energy use by 43% (Griffith et al. 2008). These studies use individual components (EEMs) instead of a refurbishing building system.

A study of Spanish supermarkets to mitigate the effects of climate change produced similar results, which showed that by using energy efficiency/saving measures, supermarkets could be made environmentally and cost friendly. A model of a typical Spanish supermarket having a sale area of 400 – 2500 m² is examined with a focus on building services such as lighting, cooling, air conditioning, ventilation, and bakery ovens. The study promotes better design

practices and efficient technology, such as better building design to reduce heat transfer, use of natural light, installing presence detectors and time programmers for light, replacing old air conditioning systems with a better efficient system, and installing an industrial automation system. Furthermore, making use of heat recovery systems and use of cooling cabinets with glass doors and lids saved an average of 25% in energy consumption (Ríos Fernández & Roqueñí 2018). It highlights that the retrofitting process and using EEMs can go a long way in reducing energy and carbon emissions while helping to achieve nZEB standards.

An investigation coming out of Sweden analysed the definition adopted by the country for nZEB. The study performed simulation and experimentation on an office building and tried to achieve the nZEB standards using only the existing technologies. It was found that the U-value and peak load heating requirements were not reached (Berggren et al., 2012). Another similar study on office buildings in Portugal suggested achieving the nZEB standards. Innovative EEMs must be combined with renewable technologies (Oliveira Panão, Camel,& Gonçalves, 2011).

The need for a clear and concise definition is cleared by all the literature reviews available today regarding the implementation of non-residential nZEB. Furthermore, several member states have released a plan or a definition to guide the progress towards nZEBs. According to one author, 'many of the national plans have missing or vague information' (D'Agostino et al. 2016), specifically missing any numerical values. Any available definitions of nZEB focus primarily on residential buildings, ignoring the residential/commercial buildings. There is also a common trend to have less to no difference between new or retrofitted nZEBs which is important to recognise as that ensures that they have inherently different characteristics (D'Agostino 2015)

7.2.2 Standards set for Non-residential nZEBs

A proper definition that universally defines nZEB and the associated values is difficult as the Energy Performance of Buildings Directive (EPDB) has set a very loose outline without any numerical targets, allowing each European country to have their own definition. Further research found that the reason for doing so was due to the differences in local climate region, level of building technology, building traditions, and level of ambition. A binding definition for nZEB for all European nations would be neither feasible nor interchangeable across the board.

Lowering the energy demand of the building is a necessary step to achieve nearly zero energy building standards. EPDB states that 'the energy performance of a building shall be transparently and shall include energy performance indicator and a numeric indicator of primary energy use, ...'. The energy performance indicator should be stipulated as 'energy needs to be heating and cooling (Kurnitski 2013)

Commercial nZEBs definitions must be completed and often offer a limited understanding. According to one definition, a net-ZEB should balance the energy demand required from the grid using renewable technologies to meet the building's demand (Voss, Musall, and Lichtmeß, 2011). Another popular definition is provided by The National Renewable Energy Laboratory (NREL), which defines nZEB as a building that generates an equal amount of energy used annually with on-site renewables. The associated emissions and the pricing point must also be considered. The International Energy Agency (IEA) defines nZEBs that do not rely on fossil fuels (Voss and Riley 2009). A similar definition states nearly zero buildings as the

ones that meet the energy demands via low-cost renewable energy sources (RES), balancing the annual energy demand with the generated renewable energy (Lewis, 2009).

Due to the knowledge gap regarding the non-residential nZEBs and vague definitions surrounding the use of renewable energy, in many cases, an energy-inefficient building has been categorised as nZEB based on the large-scale usage of the renewable technology, even though the energy demand remains somewhat unchanged (Voss, Sartori & Lollin 2012).

A more practical approach towards the numerical standards of a non-residential nearly zero energy building found in recent literature in Europe includes the 'RT2012' national law in France stating a PEC of 110 kWh/m²/year or lower for new non-residential nZEBs (Bordier, Menager, & Guen, 2016). In contrast, Austria released the Institute of construction engineering (OIB) 'Directive 6' guidelines which specified a PEC of 170 kWh/m²/year or lower for a non-residential building to be called an nZEB (Austrian Energy Agency, 2018). On the other hand, Italy released national law 'DM 20 of June 2015', which argues that the PEC of an nZEB should be calculated on a reference building along with the usage of the minimum rate of renewables' for non-residential nZEBs which would include Domestic Hot Water (DHW), HVAC, lighting, and movement of people (Paoletti, 2017). As of 2021, the UK has yet to adopt an official definition of nZEB for a non-residential building and specify the numerical targets to achieve one.

The closest definition that can be fitted onto the UK-built environment system is one adopted by tools from the EU Zebra2020 project. The project was launched in 2014 and focused on defining solutions to overcome the identified market barriers and presenting nZEB building indicators, including building features, technical systems, and passive and active solutions. This project collected data from several nZEB cases, allowing a quantitative and qualitative analysis of the building services and key features of successful nZEBs across Europe. The analysis is conducted in 17 European countries, presenting different climatic conditions, building regulations, and local nZEB definitions (Paoletti 2017).

The tools from the project are divided into three sub-parts. The first part of the tool is the 'Data tool', which provides information regarding the existing building stock divided by country and is focused on 'overcoming the data gap'. It also provides a detailed summary regarding the transition to nZEBs (Pascual 2021). The second part is the 'Tracker', which provides information regarding existing successful nZEB case studies and primary indicators such as the primary energy performance, passive and active energy-efficient solutions, and the renewable energy used. It also helps separate the residential and non-residential buildings and is available by country, assisting in shaping a definition with specific numerical targets for UK non-residential nZEBs (Table 24).

Table 25 shows a list of possible EEMs utilised in the supermarket building. These EEMs have been carefully examined and have been tested in a non-residential building in the UK (Salem et al. 2019). The main areas with a significant impact on reduced energy consumption are insulation, window glazing, lighting, HVAC, and renewable energy systems. These EEMs were selected based on the building application and their various applicable sizes as it was trialled and examined to obtain the most optimum results.

Table 25. Baseline TAS results against non-residential nZEB targets

	Baseline Model	nZEB target
Wall (W/m²k)	0.24	0.11
Floor (W/m²k)	0.21	0.10
Roof (W/m²k)	0.13	0.15
Windows (W/m²k)	3.08	0.92
Air permeability rate (m³/h/m² @50Pa)	4.0	2.00
Energy consumption (kWh/m²)	113.68	45.5
Primary energy consumption (kWh/m²)	349	140 (or at least 60% reduction)
Carbon emissions (Kg/CO₂/m²)	59	At least a 50% reduction annually

Table 26. Selected list of EEMs.

	Size/Measure	Abbreviations
Insulation	100,150,200mm sheep's wool	SW
	100,150,200mm cellulose	CE
Windows glazing	Triple Glazing, 36 mm Argon filled, Low-e	TGA
	Triple Glazing, 36 mm Air filled, Low-e	TGAA
Lighting	LED + Auto presence detection	LED+A
	CFL + Auto Presence detection	CDL+A
HVAC systems	Automatic Thermostat controlled direct gas fired Boiler	ATB
	Programmable Thermostat direct gas-fired Boiler.	PTB

	Mechanical Ventilation with heat recovery	MVHRV
	Mechanical Ventilation with energy recovery ventilator	MVERV
	Photovoltaic Panel	PV
	Biomass Boiler	BB
Renewable/microgeneration technology	Combined Heat and Power	CHP
	Combined Cooling, Heating and Power	CCHP

7.3 Methodology

7.3.1 Case study

The case study under investigation is a real purpose-built typical UK supermarket based in London. All the building data has been obtained by surveying and reviewing the building design documents to ensure the model represents the true scenario. The peak height of the supermarket store is 7.02 meters with a declining angle of 3.30,° finishing at 5.104 meters at the end. The entrance door is 5-meter-wide and 2.9-meter-tall in total. The rear elevation has a height of 4.635 meters tall. The curtain walling has double-glazed units divided into upper and lower windows.

The building modelling and simulation software TAS predicts energy performance, baseline and mitigated CO₂ emissions, and thermal performance. The total floor area is 2,500 m²; a single storey building with an entrance lobby, bakery, warehouse, toilets, and other offices including Information Technology (IT) room, cash room, utility, meeting room, cloakroom, and welfare canteen. Construction materials are assigned individually to all the building elements of the store according to the LIDL specifications, and internal conditions are applied to the individual zones. Figure 46 shows the floor plan of the LIDL supermarket building with an exposed roof.

Initially, The TAS modelling contains AutoCAD architectural building drawings of the LIDL baseline supermarket store. The drawings consist of front, rear, and gable elevations. Moreover, it has the floor and roof plans to make it as accurate as possible. It is defined as the ‘baseline model.’ The total energy consumption value obtained from TAS considers heating, cooling, auxiliary, lighting, and Domestic Hot Water (DHW); it is the net of any electrical energy displaced by renewable/microgeneration systems, if applicable. The PEC is the primary energy consumed to meet the building’s energy demand (heating, cooling, DHW, lighting, and auxiliaries). It is also the net of any electrical energy displaced by C/CHP generators, if applicable. As for the weathering profile, London Test Reference Year (TRY) files are used as the store is based in London, making them the closest/most

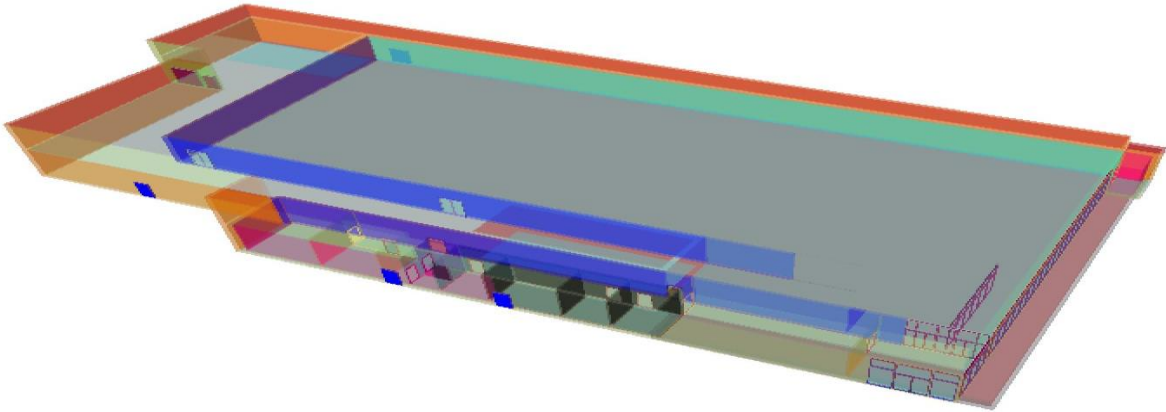

Figure 36: supermarket building in analysis mode.

7.3.2 Modelling Assumptions

1. The National Calculation Method (NCM) database represents all zones, as shown in Table 27.
2. It is assumed that these conditions are the actual current conditions of the supermarket with thermophysical properties presented in Table 28.
3. Fully adapting the CIBSE TRY weather files without any alterations and assuming that they are valid and relevant to the microclimate of London.
4. Figure 49 (a-c) shows the external temperature, global solar radiation, and the 3D visualisation of the resulting temperature in the building case study.

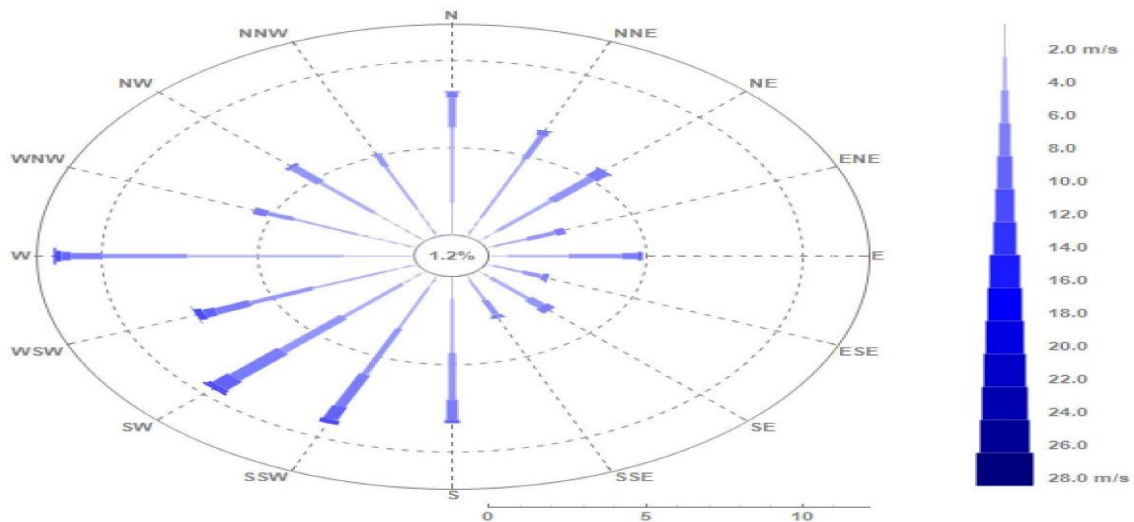

Figure 37a. London test reference year annual wind rose.

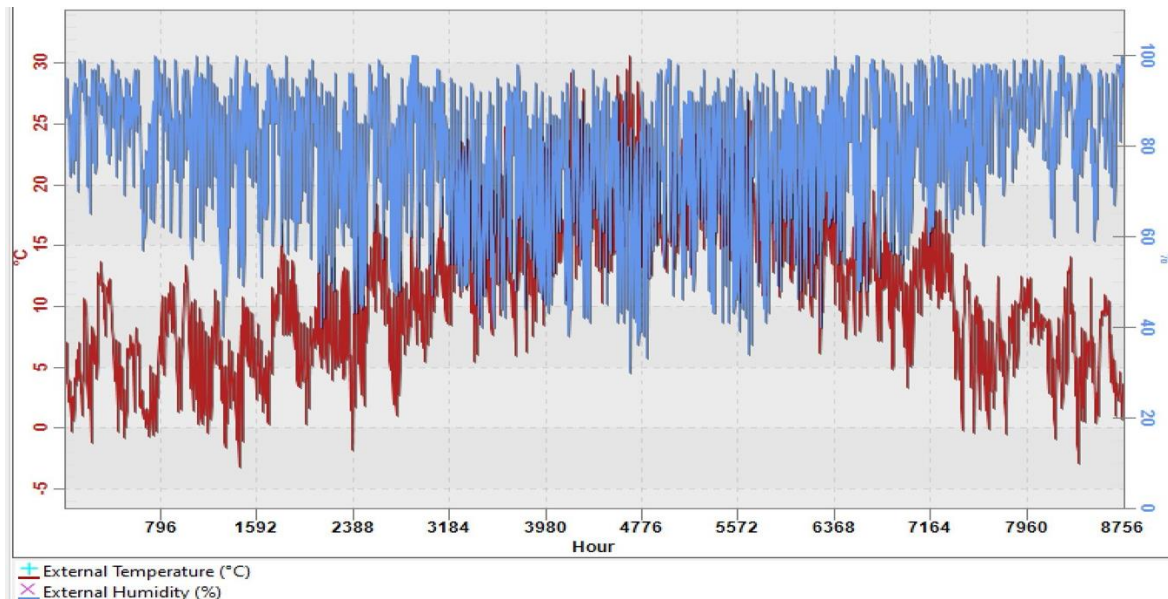

Figure 37b. London test reference year annual external temperature and humidity.

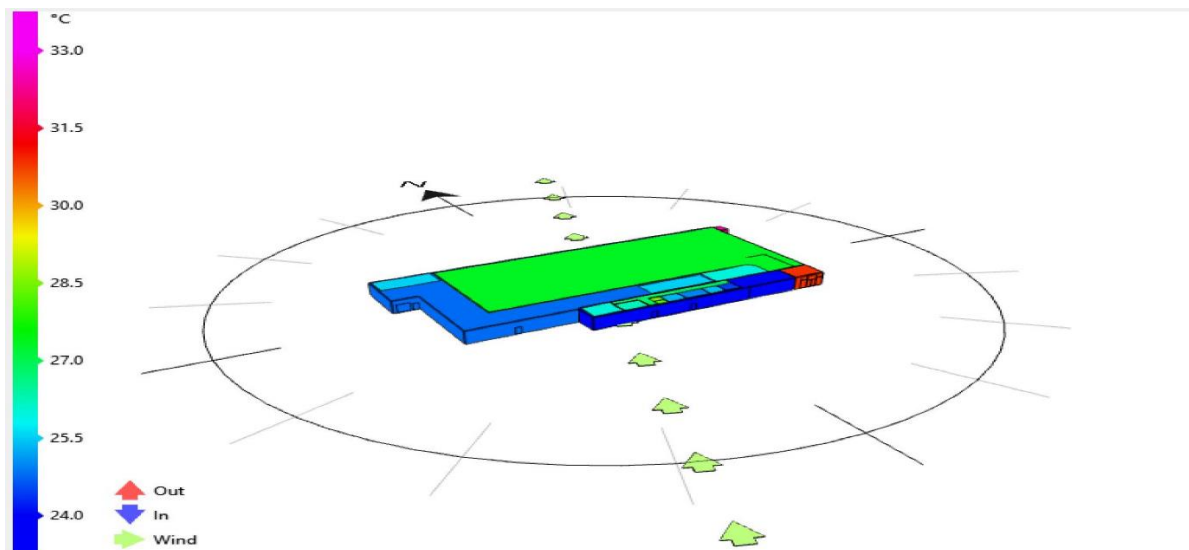

Figure 37c. Supermarket building means radiant temperature day 195.

Table 27: Building specification - NCM database.

Building Specification	NCM Standard
Air permeability	4.0 m ³ /h.m ² @ 50Pa
Infiltration	0.125 (ACH)

Fuel source	Grid supplied electricity
CO ₂ factor	0.519 kg/kWh (Electricity)
	0.216 kg/kWh (Natural Gas)
Performance efficiency – modelling	<p>Biomass Boiler – 85% efficient</p> <p>MVHR - Specific fan power – 0.5 & heat recovery efficiency – 90%</p> <p>PV – 18.3% efficient</p> <p>CCHP – 186KWe (sized duty)</p>
Weather data	<p>TRY (CIBSE) for England, London. Includes:</p> <p>Global solar radiation, Relative humidity, Wind Speed and Wind direction, Dry Bulb Temperature, Diffuse Solar radiation, and Cloud Cover.</p>

Table 28: Thermophysical properties.

Type		Conductance (W/m ² . °C)	Construction Type
Wall	Cast Concrete wall	0.974	Opaque
	Cavity wall	0.25	Opaque
	Curtain Wall	5.227	Opaque
	Metal Cladding Wall	0.235	Opaque
	Steel Frame Wall	0.379	Opaque
Frame	Uncoated glass, air-filled	5.545	Transparent
	Metal, thermal break & spacer	59.116	Transparent

	Wood, thermal spacer	7.89	Transparent
Floor	Ground Floor	0.218	Opaque
Door	Insulated personal door	0.94	Opaque
	Vehicle door	2.0	Opaque

7.4 Results and Discussions

7.4.1 Model validation

It is important first to validate the model against the actual supermarket to reflect the actual state of the building without any alterations. Results obtained from the TAS simulation are compared against the actual building's energy consumption. The simulation model was carefully designed to reproduce all the characteristics of the supermarkets. However, it is still widely accepted that there can be an over/under estimation regarding the actual energy consumption. The reason is that the accuracy of the simulation results depends on factors such as the weather data used for the simulation, which should ideally replicate the microclimate of the building's location and actual occupancy rates (Amoako-Attah & Jahromi 2014; Rotimi 2018). Since this is challenging to achieve, there can be a slight variation between simulated and actual supermarket buildings (Bahadori-Jahromi et al. 2022).

7.4.2 Implementation of individual EEMs:

Though implementing the EEMs can reduce primary energy consumption (PEC) and total emissions and assist in reaching close to the nZEB targets, the differences, in this case, are less noteworthy. As the baseline model building is a newly constructed building with the most up-to-date energy-efficient measures considered by builders and academics, this building follows all the energy-efficient measures.

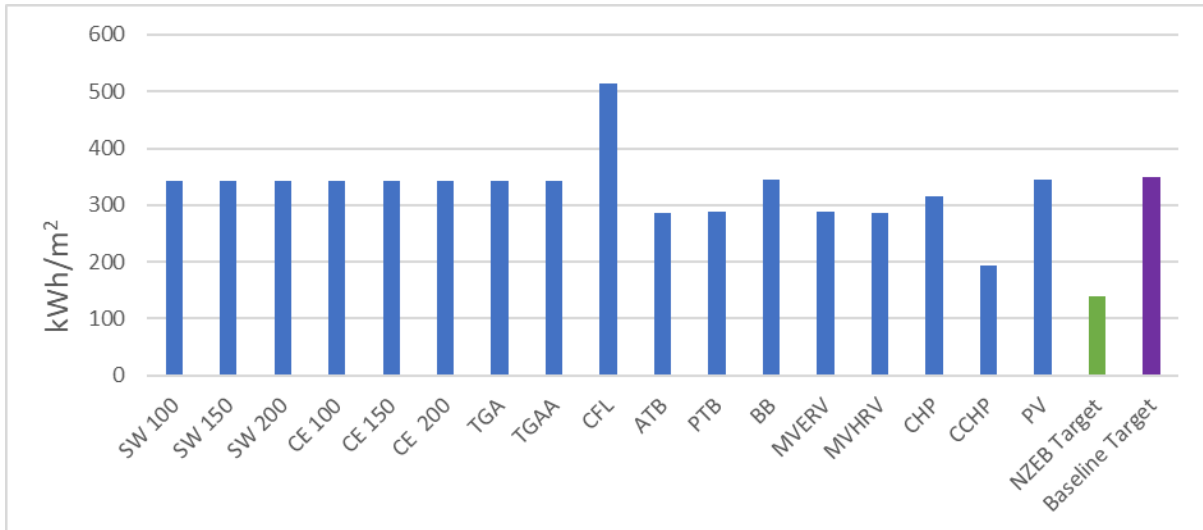

Figure 38a. Primary energy consumption with implemented measures.

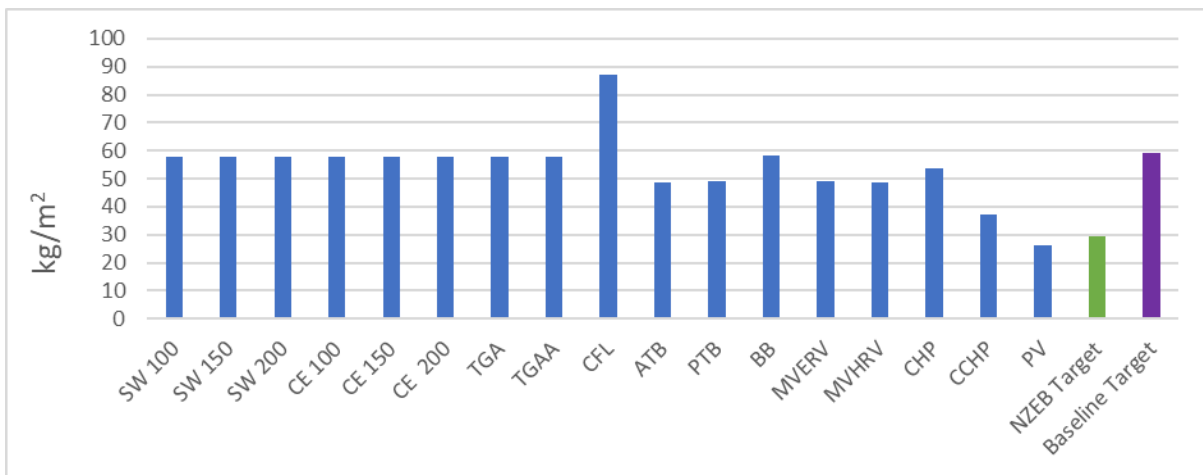

Figure 38b. Carbon emissions with implemented measures.

On that note, it is essential to focus on carbon emission reduction for the baseline model building to reach the nZEB emissions target when it comes to the operational usage of the supermarket building. Although embodied carbon of the building and the end-of-life cycle would still carry a significant percentage of carbon emissions, this study will imply that during the usage phase, the building services shall emit minimum carbon emissions, making the building as carbon neutral as possible. The next analysis phase compares the quantitative representation of the same EEMs (insulation, glazing, lighting, HVAC, and microgeneration systems) for the baseline model.

Figure 38a presents the primary energy consumption reduction contribution of each measure implemented on the typical newly built UK supermarket compared to the baseline energy consumption and how close the reduction is to the nZEB target. Looking at Figure 50a, it can be concluded that though a certain group of measures provide almost the same difference to the reduction of primary energy consumption and reaching the nZEB target, the Compact

Fluorescent (CFL) bulbs have a significant negative impact as the emissions associated are the highest as opposed to the implementation of LEDs.

Two insulation materials have been mentioned to incorporate the insulation into the baseline model: sheep's wool (SW) and cellulose (CE). As for both insulation methods, it is observed that the reduction point varies from 2% to 2.5% as compared to the baseline model. It should be concluded that any thickness (ranging from 100 to 200 mm) of these two insulation materials does not draw much attention to be covered to reach the nZEB target. Looking at Figure 50b, it can be asserted that as compared to the baseline model which has 349 k,g/m² total emission, the implementation of EEMs such as SW and CE for any thickness (100, 150 and 200mm) makes a small reduction of 2.03% in total emissions. It shows that the newly built supermarket already has many pre-installed energy measures to save energy and emissions and keep the building up to date with the latest UK building regulations.

On the other hand, Figure 50a remarks that to assimilate glazing as an EEM, the contribution to the reduction to achieve the nZEB target is at most 3% for both TGA and TGAA. Figure 38b presents total emissions, where the reduction value remains 2.03% for the above-mentioned energy-efficient measures compared to insulation.

Lighting is one of the biggest contributions to energy and emissions in supermarkets especially given the area of the sales floor, bakery, and other offices in the back of the store. Light-emitting diodes (LEDs) are the most popular choice given their low emissions and minimum energy consumption compared to the simulation with CFL as an EEM, which showed an increase of 47.59% in energy and a similar increment of 47.62% in total emissions.

Incorporating Automatic Thermostat Controlled Direct Gas Fired Boiler (ATB), Programmable Thermostat Direct Gas Fired Boiler (PTB), Biomass Boiler (BB), Mechanical ventilation with Energy Recovery Ventilator (MVERV), and Mechanical Ventilation with Heat Recovery (MHHRV) has the potential to offer a significant improvement to reduce the primary energy consumption of the supermarket.

Based on the results of Figure 50a, BB still consumes the highest primary energy among other HVAC, lowering only 1.25% than the baseline model. ATB and PTB have significantly lower energy consumption than BB, with 18.10% and 17.49%, respectively. Figure 50b shows the total emissions reduction is also directly proportional, where ATB and PTB have 17-18% reduction compared to the baseline model and BB only has 1.2%. Coming to MVERV and MVHRH, a similar reduction pattern is observed, like ATB and PTB, and therefore the reduction is also quite similar whether it is PEC or total emissions. Combining both will produce no substantial results as the combined effects average out, and no significant reduction in outcomes is observed.

Furthermore, when trying to reach the nZEB targets with the help of the microgeneration systems, Figure 50a shows that with Combined Heat and Power (CHP), the primary energy consumption reduction was 9.66%, and with Combined Cooling Heating and Power (CCHP) the reduction was 44.44%. As shown in Figure 50b, the CHP and CCHP respectively reduced by 9.32% and 36.61% reduction in total emissions as compared to the baseline model.

7.4.3 Reaching Close to nZEB Using the best combination of EEMs.

A comparison of PEC and the total emissions for the EEMs is highlighted before. It shows that the results are only sometimes up to the desired standard, even with a highly energy-efficient

energy-saving technique. Combining all the best and most efficient EEMs can produce a result closest to the nZEB target for the building. Several issues are highlighted when evaluating the significant reductions achieved with different combinations of EEMs.

Firstly, to achieve the nZEB targets for PEC and the total emissions, more than the sole use of CHP/CCHP is needed. It is important to incorporate several additional measures, most significantly using PV panels. As the EPBD states, the nZEB definitions and targets rely heavily on each European country by their standards and have focussed on the PEC as the main indicator for residential and commercial nZEBs. Not achieving the nZEB target for energy consumption due to incorporating CCHP should uphold its benefits, which significantly lowers the PEC and carbon emissions, as shown in Figure 51a and Figure 51b. While there could be other renewable technologies that can be further explored to lower and meet the target, a payback period analysis was conducted to evaluate the economic feasibility of these technologies. The analysis considered the initial investment costs, operational costs, energy savings, and potential incentives. The results indicated that the mix of CCHP and PV panels, automatic presence detection LED, direct gas boiler, and mechanical ventilation with heat recovery provides the most economically viable solution with the shortest payback period. On the other hand, incorporating double glazing and CFL lighting was found to be the least favourable combination, specifically due to the increased lighting demand and longer payback periods.

Another important thing to note is that due to the newly built nature of the supermarket building, only a few of the EEMs make a significant difference, whether it comes to lowering the PEC or the total emissions. And it is quite apparent that only the incorporation of insulation, lighting, HVAC, and CCHP offered the biggest reductions, which resulted in a drop of 45% compared to the baseline model in primary energy consumption and the carbon emission of a single digit.

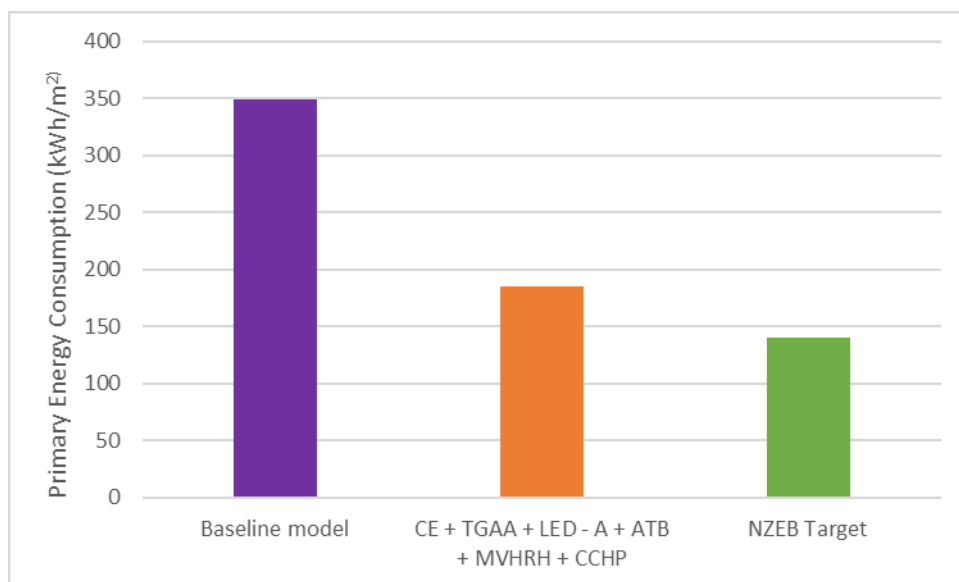

Figure 39a. Effect of combination of EEMs on PEC.

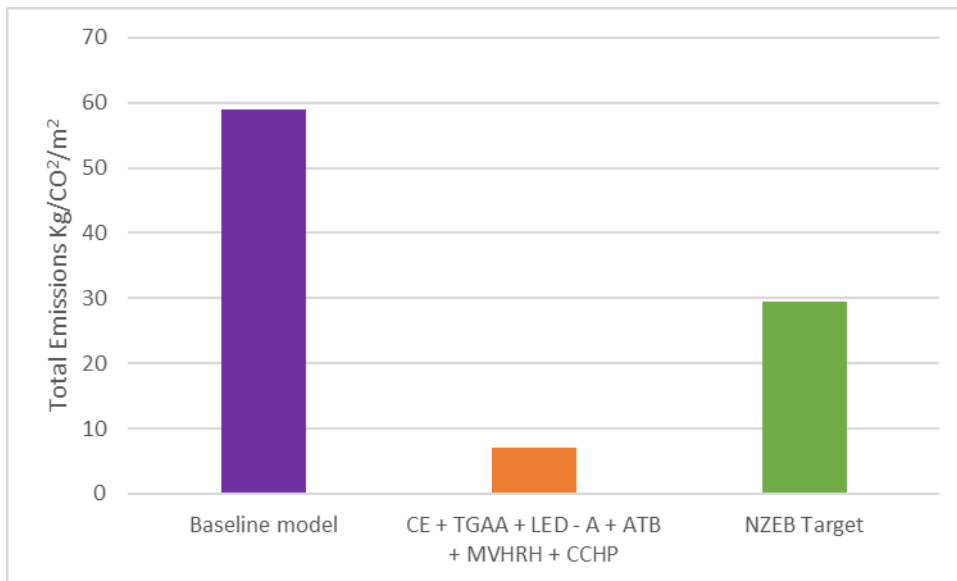

Figure 39b. Effect of Combination of EEMs on the total emissions reduction.

7.5 Conclusion

Using Thermal Analysis Software, this paper presented a comprehensive analysis of incorporating various energy efficiency measures and their role in reducing primary energy consumption and carbon emission. The research's outcome has been to explore the factors contributing to reaching the nZEB target of the supermarket building. The combination of different EEM selections has been useful to the research, which expands upon the fact that important initiatives should be taken besides investigating renewable technology to lower the PEC. Even with the incorporation of insulation, glazing, microgeneration, and renewable technologies, the nearly zero energy building standards still needed to be completely achieved. A more detail-oriented exploration of renewable technologies could better reduce the supermarket building's energy consumption and total emissions. Moreover, it is also important to consider the site, location, and size, among other important factors. Certain improvements, such as the auto-presence feature for lighting and using natural gas as a fuel source, can make a clear difference in a building like a supermarket.

It is noteworthy that though the research paves out a path for the supermarket building to reach the desired nZEB target, it does not quite reach the actual numbers, and it does not nullify the possibility of attaining the same. The nZEB target can be reached by combining and incorporating microgeneration technologies. It could lower the primary energy consumption and CO₂ emission and reach the nZEB standard. The mix of CCHP and PV panels, automatic presence detection LED, direct gas boiler, and mechanical ventilation with heat recovery attains the closest value to the nZEB targets.

Chapter 8 - Comparative analysis of the whole life carbon of three construction methods of a UK-based supermarket

8.1 Introduction

The built environment has been a significant contributor to global carbon emissions. It, therefore, has a vital role to play in the reduction efforts of future climate change. While the design of buildings may determine future energy use for cooling, heating, and lighting during the operational stage of the building, this study aims to observe the effect of the building design on the operational as well as the whole-life carbon emissions. Past studies have focused on either the operational carbon or the embodied carbon of a building. This study uses a cradle-to-grave assessment of a typical UK supermarket to explore the relationship between embodied and operational carbon.

Additionally, it examines the effects of the variables between three approved construction methods of the same design on the whole life of carbon. These methods are a steel structural frame and cladding panel external wall, steel frame and proton walls, precast concrete and glulam frame and precast concrete walls. The findings of this research will contribute to mitigation strategies for the environmental impacts of supermarket building construction whilst providing a framework for future assessment of the whole-life carbon of supermarket buildings.

8.1.1 Background & Whole Life Carbon

The rise of global warming and climate change has resulted in many actions by different bodies. The UK government has approved the Climate Change Act 2008, which sets legally binding targets for greenhouse gas (GHG) emission reduction, with the Committee on Climate Change (CCC) mandated regular government progress reports on reaching the target of net-zero emissions by 2050 (Muinzer 2018). The building sector is one of the most energy-intensive and prominent contributors to GHG emissions. According to the International Energy Agency (IEA) based in Paris, the building and construction sectors are responsible for approximately one-third of total global final energy consumption and nearly 15% of direct CO₂ emissions (IEA Buildings 2022). Data published in 2019 shows that the sector accounts for 39% and 11% of global energy-based emissions, respectively (Environment UN 2019). The 2020 CCC Sixth Carbon Budget reported that UK buildings are responsible for 59% of the UK electricity consumption and 87 MtCO_{2e} of direct GHG emissions.

In contrast, the total percentage rises to 23% of total UK emissions, including indirect emissions (The Sixth Carbon Budget 2022). According to the 'Global Status Report' (Hossain, Wu, & Poon 2017), 28% of global carbon emissions are related to the operation of buildings compared to 11% attributed to embodied emissions which involve emissions associated with the construction industry. This report equally highlights the importance of reducing embodied energy and carbon emissions as a primary concern for action. However, the report gave no action plan to reduce carbon emissions and mitigate climate change. Additionally, the

construction sector uses up to 36% of the world's natural resources, accounting for approximately 50% of the solid waste sent to landfills (Hossain, Wu, & Poon 2017);UN Habitat 2022). Therefore, there is immense pressure on the building and construction sector to reduce emissions (Environment UN. 2019;UN Habitat 2022).

Carbon emissions are generally categorised into two types: embodied carbon and operational carbon. Embodied carbon is the emissions produced during the material extraction, processing, manufacturing, transportation, construction, demolition and final disposal of construction material, also called 'capital carbon' (McPartland 2017). Conversely, operational carbon is the emissions produced from energy used for heating and cooling, lighting, equipment load, and energy loads ongoing use. The Whole Life Carbon (WLC) refers to both the operational and embodied carbon of a building.

WLC reduction faces significant challenges, partially due to the emissions occurring at different life cycle stages. In reducing emissions and optimising building design, studying the operational and embodied emissions of all the available alternate design options involving the building's inputs, processes, and outputs at each stage is vital. Figure 52 demonstrates that embodied carbon emissions can be examined in two stages. The emissions produced during the building's construction (including emissions emitted from material production, transport of material, and on-site activities) are termed upfront carbon. And the emissions produced during the demolition or deconstruction of the building (including the transportation of demolished materials, processing of waste and final disposal of waste materials) are termed end-of-life carbon Richard McPartland (Adams, Burrows & Richardson 2011). This distinction is vital as juxtaposed to the end-of-life emissions. The upfront emissions occur before the building is used. Operational energy or operational carbon in buildings arises from the building's lighting, heating, ventilation, air conditioning (HVAC), and appliances. Whilst these emissions occur at different stages of the lifespan of the building and varying magnitudes, they all significantly contribute to the WLC emissions of a building (McPartland 2017; Adams, Burrows & Richardson 2011). In the past, most of the industry's focus has been reducing operational carbon. This has partially been due to the importance assigned to operational carbon and energy consumption.

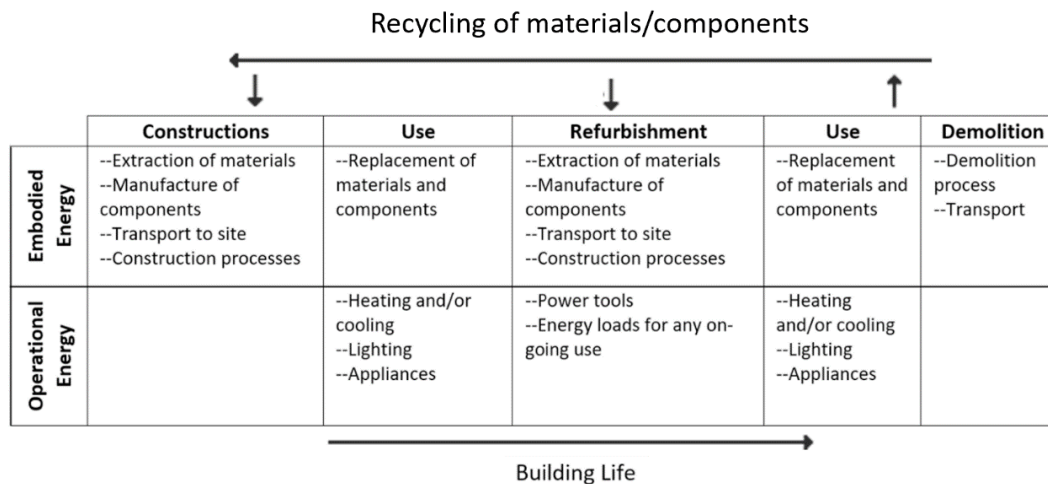

Figure 40: Indicative components of embodied and operational energy over an illustrative building life cycle recreated from (Yohanis & Norto 2002).

A study by Moncaster and Symons (Moncaster & Symons 2013) investigating the carbon impact of each life cycle stage in residential buildings showed that the proportion of the end-of-life stage ranges between 5% and 21% of total carbon emissions. (Peng 2016) notes that in a comparison study examining the whole-life carbon emissions of the domestic sector, operational carbon accounts for nearly 85.4% of the WLC. Likewise, a study by Iddon and Firth (Iddon & Firth 2013) focused on the embodied and operational carbon of new-build housing in the UK. It concluded that operational carbon accounts for approximately 74–80% of WLC over 60 years. Additionally, several studies have revealed that the operational phase is responsible for 80-85% of the life cycle carbon emissions in buildings. (Sharma et. al 2011; Robot et al. 2021), while the remaining stages of a building's life cycle account for 15-20% (Asdrubali et al. 2105).

In contrast, a study by Röck et al. (2020) conducted a systematic review to ascertain the global trends of carbon emissions occurring throughout the life cycle of buildings, analysing over 650 LCA case studies. The review categorised different energy performance classes based on a final sample of 238 cases. The study found that while the average embodied carbon emissions from buildings are about 20–25%, the share of embodied carbon rises to about 45–50% in highly energy-efficient buildings and can exceed 90% in extreme instances. Likewise, Andersen et al. (Andersen 2021) carried out a systematic review of 226 different scenarios to investigate embodied carbon emission results reported in Life Cycle Assessment (LCA) studies. The analysis concluded that, in general, the average reported values of timber buildings range between 33% and 50% of embodied carbon emissions of buildings. Nevertheless, the findings showed that the importance of operational carbon is reducing. In contrast, the significance of embodied carbon becomes greater due to advances in energy efficiency and stricter regulations for energy efficiency in buildings. These reviews highlight an increasing need and significance to optimise buildings' operational and embodied carbon emissions.

8.1.2 Practical Application

Employing the life cycle assessment methodology, this paper examines the potential of minimising embodied and operational carbon by observing the whole life of carbon., Highlighting the influence of the GHG emission contributing factors in each stage on each other. Additionally, the recommended methodology for the supermarket building types of this case study could be adapted for other types of buildings. The findings could also augment carbon emission research and guide the development of supermarket buildings to low carbon intensive. Furthermore, collaboration with the industry in carrying out this research aids in adopting the findings as practical and theoretical guides for engineers and designers in reducing the building sector's harmful environmental impact.

8.2 Whole Life Carbon in Supermarket Buildings

Additionally, limited research is available focusing on UK supermarkets' operational carbon emissions. Less attention has been placed on quantifying and reducing the impacts of the other phases of the building's life cycle (Hassan et al. 2020). Several studies have focused on calculating and lowering commercial buildings' emissions, specifically supermarkets. Such as a study in 2018 conducted on Spanish supermarkets with sale areas of 400 – 2500 m² focused on reducing the final energy consumption of its building services such as lighting, cooling, air conditioning, ventilation, and bakery ovens. Reducing it by an average of 25% using natural light, installing presence detectors, time programmers for light, replacing old air conditioning systems with a better efficient system, and installing an industrial automation system (Ríos Fernández & Roqueñí 2018). On the other hand, the adoption of a circular economy (CE), which addresses issues of resource scarcity and climate change (MacArthur 2013), is considered an appropriate solution for managing waste from electrical and electronic equipment (WEEE). As it seeks to close the loop of the product life cycle, reduce emissions and retain the highest value of the product (Geissdoerfer 2017). Refrigerators and other appliances make the supermarkets ideal for studying the potential implementation of CE (Bressan et al. 2020; Bressanelli et al., 2020). A study conducted in 2015 analysed energy consumption data of 565 supermarkets in the UK and revealed a 3.30% annual reduction in energy consumption between the years 2013 and 2017 where in over the five years, the total energy consumption reductions achieved were a 32% reduction in lighting, 20% in refrigeration and 8% in HVAC systems (Foster et al. 2018).

Typical supermarkets in the UK are described as high energy usage intensity (EUI) buildings due to their increased refrigeration and lighting needs. By examining the breakdown of the energy use in these buildings (Figure 53), it can be observed that small power demands (referring to energy used by small appliances, equipment, and CCTV) represent a significant proportion of total emissions and that lighting is the greatest regulated energy use (Bressanelli et al. 2020). Considering this, structural and building fabric differences could affect the emissions of each stage of the building's life cycle differently.

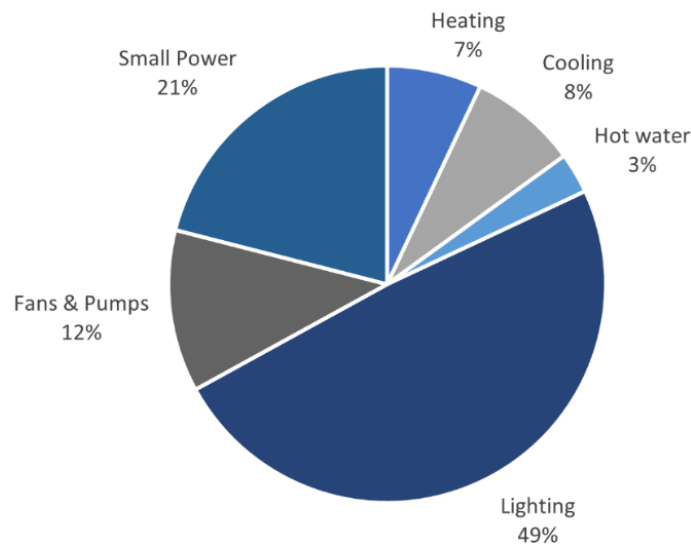

Figure 41: Breakdown of energy use in a typical supermarket (Target Zero Information Line 2011).

Additionally, there is no specific agreed single value for the whole life carbon emissions for supermarket buildings in the UK, and this is due to several reasons, such as unavailability of Environmental Product Declarations (EPDs), unavailable or missing information regarding the raw materials used, varying use of building services equipment and specific technical details regarding equipment.

Numerous studies have attempted to explain the comparative ecological advantages of concrete, steel and timber structural systems (Skullestad, Bohne and Lohne,2016; Teshnizi et al., 2018; Hart, D’Amico, Pomponi, 2021). Although extensive research has been carried out on structural systems, no single study exists that analyses supermarkets' construction developments. Therefore, fresh insight into the environmental impacts of such construction developments is vital. This paper seeks to provide a holistic view of supermarkets' material components and construction developments. They are comparing carbon with the operational and whole-life carbon of three construction approaches of a supermarket in the UK.

8.2.1 Life Cycle Assessment (LCA)

Life cycle assessment (LCA) is an internationally accepted systematic and holistic methodological technique used to evaluate the environmental impacts of any product or procedure, including building materials and construction developments. An LCA can be used to assess the environmental effects of a product throughout its life span - from raw materials extraction to final disposal. Not only does an LCA quantify the impacts of the construction of a building at different phases, but it also provides a better understanding overview of a wide variety of building components. The literature on life-cycle analysis has highlighted the importance of building materials and embodied energy in a whole life-cycle carbon emissions assessment of buildings (Wolf 2015; Akbarnezhad & Xiao, 2017; Tecchio et al. 2019).

An LCA is primarily performed in four stages (Figure 54). In the first stage, the Goal and Scope, based on the goal of the assessment, the scope and the stages included are determined. In the second stage, the Life Cycle Inventory (LCI), all data required for the assessment are identified and collected. In the third stage, Life Cycle Impact Assessment (LCIA), the potential environmental impact of the stages included in the scope are calculated. The final stage is the

Life Cycle Interpretation stage, in which the results from the LCI and LCIA stages are evaluated.

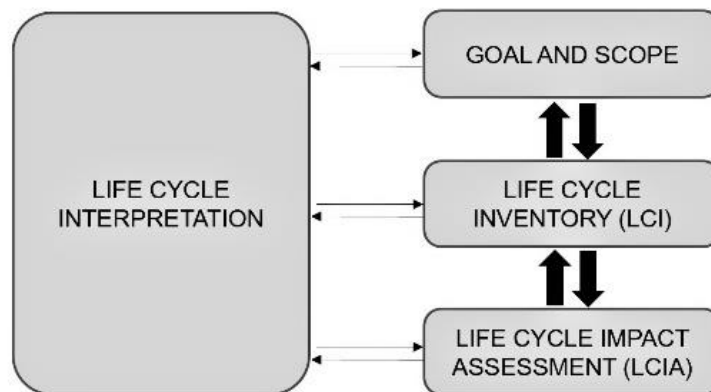

Figure 42: LCA stages reproduced from ISO 14040 (British Standards Institution 2006).

This research aims to estimate and evaluate the embodied and operational GHG emissions of supermarket buildings in the UK. This is achieved by calculating the life cycle carbon emissions. The results can offer quantifiable and comparable carbon emissions for further reduction in similar UK buildings.

8.2.1.1 Goal & Scope

The goal of this research is to compare the WLC of three variations of a typical Lidl supermarket. These three structures follow the same design and HVAC systems, and the variations, given in table 29, are the materials of the external walls, internal walls, columns, and beams. Therefore, the components included in the embodied carbon calculations are confined to the known variables. For the operational carbon, considering the building type, pattern of use and relevant technical and functional requirements, based on the ISO15686-1:2011 guideline (British Standards Institution 2011) an average service life of 20 years is assumed for this study. According to the CIBSE guide to the replacement rates of building services (Prudence Year 291,4) the components included in the study with Reference Service Life (RSL) under 20 years would be identical in all three designs. This would similarly apply to the emissions from refrigerant types and leakage rates.

The life cycle of a building has been conventionally divided into four stages, including, A (product and construction), B (in use and operation), C (end of life), and D (beyond the life cycle) (Figure 55). The scope of this research consists of the embodied and operational carbon emissions of the three defined buildings, including A1 – A3 phases termed as 'extraction of material', 'transportation' and 'manufacturing', A4 – A5' construction', B6-B7' use' and C1 – C4' end of life phases. These four stages, as illustrated in Figure 4, are considered the system boundary of this study.

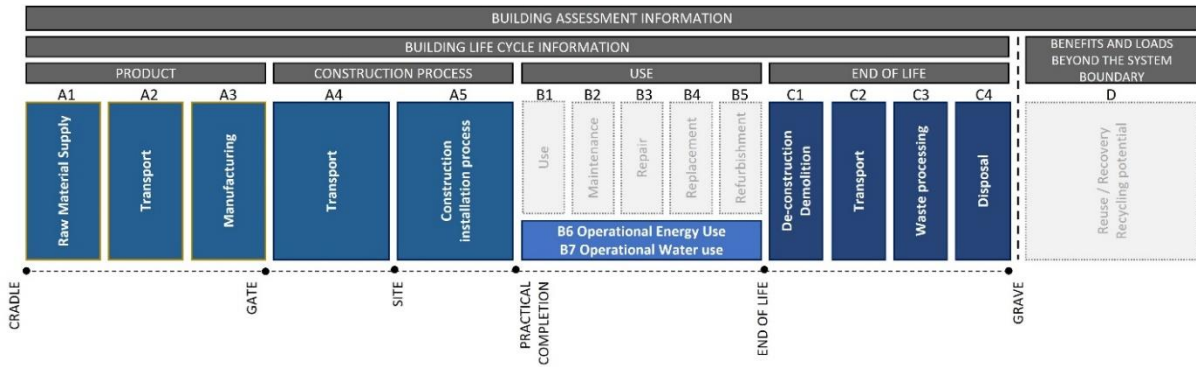

Figure 43: Life cycle stages reproduced from BS EN 15978-2011 (Environmental management 2021).

8.3 Methodology

8.3.1 Case Study

The building chosen for this case study, was the standard design of a LIDL supermarket. The standard design comprises a 2500 m² single-story building. For this standard design, there are three approved methods of construction as depicted in Table 1. The first method of construction (referred to as P1) is composed of a steel column and structural beam frame, cladding panel external walls and a concrete slab foundation. The second method of construction (referred to as P2) is composed of a steel column and structural beam frame, proton external walls up to Height(H)=4.109m and cladding panel external walls from H=4.109m to H=5.104 - 7.02m, with a concrete slab foundation. The third construction method (P3) is composed of a pre-cast concrete column and glulam beam structural frame, pre-cast concrete external walls up to H=4.109m and cladding panel external walls from H=4.109m to H=5.104 - 7.02m, with a concrete slab foundation. The internal wall finishes for P1, P2 & P3 include paint to plasterboard. The floor coverings are ceramic tiles, vinyl, and paint. The windows are glazed and aluminium-framed with external steel doors.

A Whole Life Carbon (WLC) assessment was carried out within the previously defined boundaries for each of the three construction methods (P1, P2, P3).

External Wall	Columns	Beams
Cladding panel	Steel	Steel

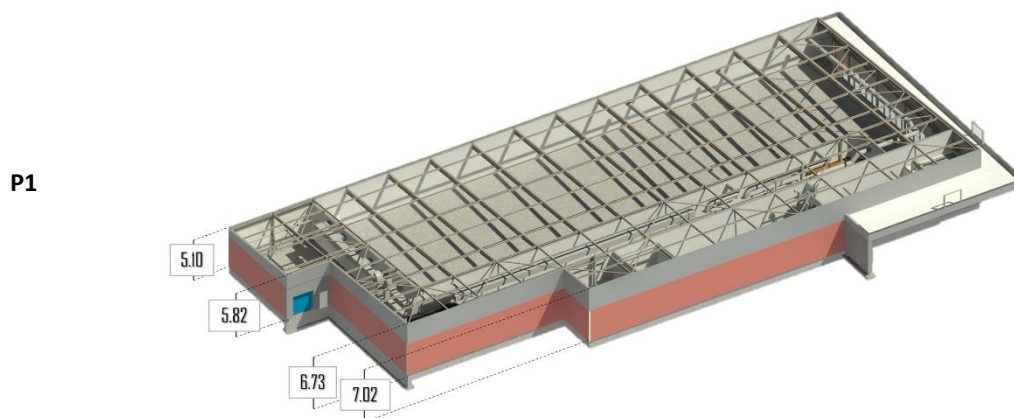

	External Wall	Columns	Beams
	Poroton block + Cladding panel	Steel	Steel
P2			
	External Wall	Columns	Beams
	Pre-cast concrete + Cladding panel	Pre-cast concrete	Glulam
P3			

Table 29: Simulated standard design model for three construction methods of LIDL supermarket buildings using Autodesk® Revit® BIM software: Isometric view of the model.

8.3.2 Life Cycle Inventory (LCI)

In this study, two different software tools have been utilised to aid the WLC assessment—the Autodesk® Revit® BIM software and the TAS (Thermal Analysis software) by EDSL.

The material quantities necessary to calculate the embodied carbon were derived by simulating a 3D model for P1, P2 & P3 using Autodesk® Revit® BIM software (Table 29). The model was designed with the closest accuracy to the plans. The Revit® material library was used to assign materials to the simulation and modified to match the plan’s physical attribute specifications. The material quantities for each model are illustrated in Table 30. As mentioned, one of the main barriers to performing a WLC assessment is the lack of specific EPDs. Therefore, considering that all three models follow the same HVAC system design, in this research, the embodied carbon of the ducts, pipes and electrical cabling has been included while the building service units (AHU, HVAC, DHW) have been omitted.

Additionally, to keep the findings of this study in line with the research goal, certain limitations were placed on the consideration of different factors which could be explored in future studies. Such refrigerants in the supermarket store, and refrigerant leakage. However, this omission

allows for calculating the WLC to be further adapted to other building types such as offices, retail buildings and warehouses.

Table 30: Summary of material quantities.

Category	Material Weight (tonne)		
	P1	P2	P3
Ceilings	5.97	5.97	5.90
Floors	365.41	365.42	371.94
Foundations	1,148.53	1,141.88	1,148.53
Framing	89.89	89.89	240.74
MEP (Mechanical, Electrical, Plumbing)	4.58	4.58	4.58
Roofs	56.59	56.59	55.93
Walls	359.11	637.14	698.87
Windows + Doors	10.44	10.44	10.44
Total	2,040.51	2,311.92	2,536.93

The TAS software, which incorporates CIBSE weather files and complies with the building regulations guidance 2010: Part L2 for England and Wales (Pan & Garmston 2012) was used to calculate the energy use and emission of the three models. As the software allows for changes to the building fabric and given that P1, P2 and P3 do not differ in floor plan design, a 3D model of the building was simulated is provided in figure 44. These building plans are specific to the UK, so the construction methodology is done according to the Building Regulations 2010 (Akbarnezhad & Xiao 2017). A further explanation and detailed description of TAS have been outlined in previous papers (Amirkhani et al. 2017; Bahadori-Jahromi 2022).

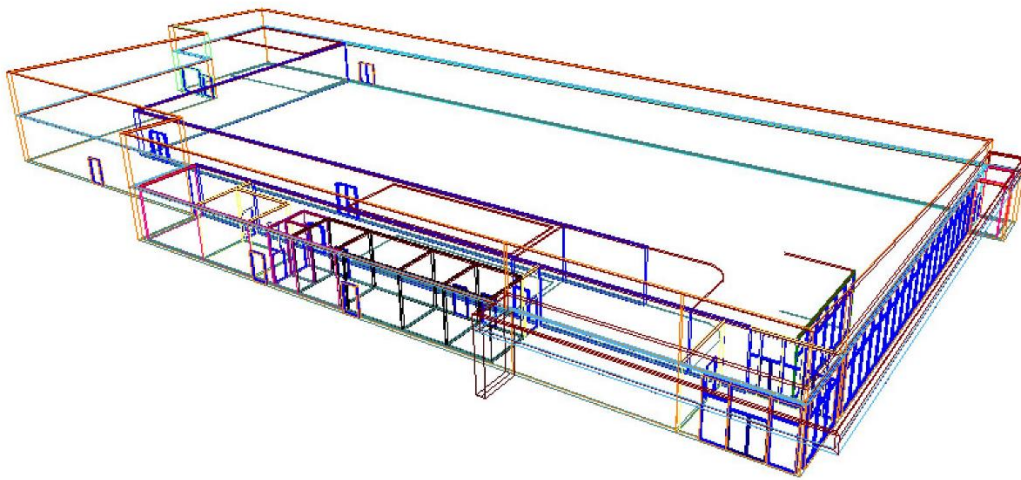

Figure 44:3D model building geometry in TAS – EDSL.

8.3.3 Calculation

8.3.3.1 Embodied Carbon (A1-A5, C1-C4)

The embodied carbon of the cladding panels, roof panels, floor tiles & ceiling tiles was calculated by using the LIDL approved supplier's manufacturer EPDs for the available embodied carbon stages of the corresponding materials provided in table 31.

Table 31: Table depicting the available embodied carbon factors provided in the EPDs.

Component	Material	Global Warming Potential (GWP)									
		A1	A2	A3	A4	A5	C1	C2	C3	C4	
Sandwich panel	Double-skin sandwich panel (mineral wool core)	X	X	X	X	-	-	-	-	X	
Roof	Double skin sandwich panel (polyurethane core)	X	X	X	X	-	-	-	-	X	
Ceiling	Ceramic tile	X	X	X	X	X	X	X	X	X	
Floor	Porcelain tiles	X	X	X	X	X	X	X	X	X	

Upfront embodied carbon involves A1-A3 – the emissions from the production process of the building materials. In lieu of the availability of an EPD for the materials, these values were calculated via equation 1 (given below). Which ECF represents the embodied carbon factor which is the potential environmental impact of each material or process per unit weight. The best resource for ECFs in the UK is the ICE database (Bahadori-Jahromi, Ferri & Mylona 2022; Mohebbi 2021), which has been utilized this research.

Equation 1 – Embodied carbon for material production (A1-A3) (Gibbons & Orr 2020)

$$EC_{A13} = \sum_{i=1}^n [Q_i (ECF_{A13,i})] \quad EC_{A13} = \text{A1-A3 embodied carbon}$$

Q_i = the quantity of i^{th} material $ECF_{A13,i}$ = embodied carbon factor of i^{th} material

In line with industry-standard practice, an assumption of steel with 59% recycled content for the steel frame and precast concrete beams and columns with steel reinforced with European recycled steel was made. For the remaining components, virgin materials were assumed to avoid undercalculation of the environmental impact. Additionally, based on LIDL's practices, locally or nationally sourced materials were assumed unless the source was specifically stated. The A1-A3 embodied carbon of the glulam frame was calculated with the assumption of no carbon storage. Including the sequestered carbon value in the A1-A3 EC of the glulam frame depends on the end-of-life scenario.

The embodied carbon factor for the transport stages (ECFA4/C2) is calculated using equation 2 (given below). Where TD mode represents the assumed transport distance and TEF mode represents the transport emission factor for each transport mode. Using guidelines provided in the RICS manual (RICS,2017), a fully laden road transport, with a value of 0.07524 gCO₂e/kg/km, is assumed for the TEF mode of road transport. Using the same guidelines, the TD for each material were assumed as depicted in Table 32.

Equation 2 - Carbon factor for transportation (A4,C2) (Gibbons & Orr 2020) , , $ECF_{A4/C2,i} =$

$$\sum_{mode} (TD_{mode} \times TEF_{mode})$$

$ECF_{A4/C2,i}$ = embodied carbon factor of transport to/from site for i^{th} material

TD_{mode} = transport distance for each transport mode considered.

TEF_{mode} = transport emission factor for each transport mode considered.

Table 32: Default value assumed for material transport distance for A4 and C2 stages.

Stage	TD (Km) by road		Assumption
A4 transport scenario	Local manufacturing	50	<ul style="list-style-type: none"> • Default Ceiling • Concrete • Steel Beams & Columns • Plaster Board • Pipe & Pipe Fittings • Duct & Duct Fittings
	National Manufacturing	300	<ul style="list-style-type: none"> • Default Flooring • Gutter & Roof flushing • Metal stud internal walls • Timber walls
	European manufacturing	1500	<ul style="list-style-type: none"> • Schueco Windows • Assa Abloy Doors • Arcelor Mittal Roof Panel • Arcelor Mittal Cladding Panel
C2 Transport Scenario	Local manufacturing	50	<ul style="list-style-type: none"> • All material

The emissions from on-site waste (ECA5w) were calculated using equation 3 (given below), where WF represents the waste factor. Where applicable, the WF chart from the WRAP Net Waste Tool data was used and where not applicable based on the guidelines a default value of 1% was assigned (Gibbons & Orr 2020).

Equation 3 - Embodied carbon for construction waste (A5w) (Gibbons & Orr 2020)

$EC_{A5w,i} = WF_i \times (ECF_{A13,i} + ECF_{A4,i} + ECF_{C2,i} + ECF_{C34,i})$ $ECF_{A5w,i}$ = construction waste embodied carbon factor i^{th} material. WF_i = waste factor for i^{th} material given by Equation 4. $ECF_{C2,i}$ = transportation away from the site, calculated in the same way as $ECF_{A4,i}$ but transport distance is assumed to be 50km by road if taken for reuse or recycling. $ECF_{C34,i}$ = waste processing and disposal emissions associated with construction waste material. $ECF_{A13,i}$ = carbon sequestration for any timber products wasted during construction.

The embodied carbon associated with deconstruction/demolition (EC_{C1}) was estimated using equation 4 (given below). Where m is the type of machinery for on-site operation, and e is the type of energy used. And the carbon emission associated with the processing of demolished waste (EC_{C3}) was calculated using equation 5 (given below).

Equation 4 - Embodied carbon for deconstruction/demolition (C1) (Prudence & Green 2020) $EC_{C1} =$

$Q_{machinery,m} \times (Q_{energy,m} \times ECF_{energy})$ EC_{C1} = carbon emission associated with dismantling or demolishing the building. $Q_{machinery,mi}$ = the type of plant/equipment to demolish the building.

$Q_{energy,mi}$ = the type of fuel used by the demolition plant/equipment. $ECF_{energy,m}$ = carbon emissions per unit consumption of fuel

Equation 5 - Embodied carbon for demolished waste (C3) (Gibbons & Orr 2020) $EC_{C3} = \sum_i(Q_{wp,i} \times ECF_{C3,i})$ $EC_{C3,i}$ = carbon emissions associated with processing waste the i^{th} material. wp $Q_{wp,i}$ = the quantity of i^{th} material for waste processing. $ECF_{C3,i}$ = waste processing embodied carbon factor of i^{th} material

The carbon emission associated with the treatment of demolished waste disposal (EC_{C4}) was calculated using equation 6 (given below). At the end of the building's useful life, the structure is assumed to be demolished, materials are recycled according to the current UK recovery rate, and the remaining is sent to a landfill. As there is no current regulation, an end-of-life scenario of reuse or recycling cannot be determined or guaranteed for the glulam timber material. The captured carbon for the glulam frame is assumed to be released during this stage.

Equation 6 - Embodied carbon for material disposal (C4) (Gibbons & Orr 2020) $EC_{C4} = \sum_i(Q_{wd,i} \times ECF_{C4,i})$ $EC_{C4,i}$ = total carbon emissions associated with waste disposal of the i^{th} material. $Q_{wd,i}$ = the quantity of i^{th} material for waste disposal $ECF_{C4,i}$ = waste disposal embodied carbon factor of i^{th} material

The total amount of embodied carbon in the building was calculated using equation 7 (given below).

Equation 7 – TEC = $EC_{A1-A3} + EC_{A4} + EC_{A5} + EC_{C1} + EC_{C2} + EC_{C3} + EC_{C4}$

8.3.3.2 Operational Carbon (B6-B7)

The operational energy consumption and the associated emissions of P1, P2 and P3 were calculated using TAS software in which the building services were kept identical, and the building fabric was changed accordingly. The simulation of the LIDL supermarket building was taken as a typical UK supermarket building. The model was designed with the closest accuracy to the plan's measurements. The sales area, entrance lobby, bakery, warehouse, toilets, and other offices, including IT room, cash room, utility, meeting room, cloakroom, and welfare canteen, were defined in the model.

Crucially, other parameters set in the TAS software package included using the National Calculation Methodology (NCM) standard calendar to reflect the operational hours of the supermarket and the floor area size fixed to be 2,500 m² as per the actual building (Table 33). The internal conditions of the individual spaces, such as the entrance lobby, corridor, water closet (WC), welfare and other rooms, were assigned according to the NCM.

The construction materials were assigned to the build elements. The thermophysical characteristics of the building materials, specifically walls, frames, floor, and doors were defined to generate the BRUK-L report. Further data regarding 3D Modelling, modelling process, simulation building/process and data collection can be found in Hasan et al. (2022).

Table 33: Simulation assumptions: building summary specification.

Simulation parameter	Assumption set
Calendar	NCM standard
Air permeability	5.0 m ³ /h.m ² @ 50Pa

Infiltration	0.125 (ACH)
Fuel source	Grid supplied electricity
CO₂ factor	0.21107 kg/kWh

Table 34: Simulation assumptions: building fabric specifications.

Building element	Calculated area-weighted average U-values (W/m²K)
Wall (average)	0.24
Wall (Poroton block)	0.18
Wall (Precast concrete)	0.69
Floor	0.21
Roof	0.13
Windows	3.08
Personnel doors	1.32
Vehicle access doors	1.78
High-usage entrance doors	3.34

The HVAC systems applied in the operation of the building include the heating, cooling, and domestic hot water circuits as prescribed for each individual zone of the supermarket building. The systems are equipped with plant rooms consisting of 3-pipe variable refrigerant flow circuits (VRF), sales air handling unit (AHU) VRF circuits, and local electric DHW circuits with grid-supplied electricity as a fuel source. The VRF HVAC systems consist of outdoor units connected to multiple indoor units via refrigerant piping, providing cooling and heating to individual zones. A natural vent is used for the entrance lobby without heating or cooling. The sales area uses a VRF with mechanical ventilation. The welfare and storage airside configuration consists of mechanical ventilation with heat recovery (MVHR) with direct/storage electric heater or heat pump (electric) for heating and air conditioning (AC) for cooling. Furthermore, an AC-only VRF for extract only with no heating or cooling is applied to the storage/delivery warehouse, bakery, and customer WC.

Additionally, to keep the findings of this study in line with the goal of the research, certain limitations were placed on the consideration of different factors, such as the application of on-site renewable energy sources, such as photovoltaics (PV), wind turbines, combined heat, and power (CHP). However, exploring these options would go beyond listing the magnitude and direction of random and systematic errors, affecting the validity process of this study. Further studies could investigate various on-site renewable energy sources, quantifying their impact on energy and cost savings over a fixed period. Similarly, investigating the EC calculation of HVAC systems used in the supermarket building, as well as considering various refrigerant systems (e.g., R404a/R448) and refrigerant leakage.

Previous studies have observed the supermarket buildings' performance in other major cities such as London, Manchester, and South Hampton. As Norwich is located in a different part of the climatic region of the UK than the other major cities, the city of Norwich is selected as it lies in the specific climatic region of Eastern England, about 100 miles North-East of London and is the largest city in East Anglia.

CIBSE provides two datasets for energy use analysis: Test Reference Year (TRY) files for energy assessments and Design Summer Year (DSY) files for overheating analysis. As the model is designed in Norwich, this study will use current and future CIBSE Norwich TRY weather files for evaluation (CIBSE Guide J 2002). The CIBSE future TRYs are based on the

UKCP09 projections (Eames, Kershaw & Coley 2010). Furthermore, the TRY files are used for predicting average energy consumption and compliance with the UK building regulations, which is required while planning a new building (Eames, Ramallo-Gonzalez & Wood 2015). Due to the limited literature on energy consumption and carbon emissions analysis in buildings, this paper focuses on the supermarket building in Norwich.

8.4 Results & Discussion

8.4.1 Embodied Carbon

The embodied carbon of P1, P2 and P3 was calculated within the defined parameters (Figure 37). The preliminary carbon emission analysis results show that the P2 model contributed the least carbon emissions, with a total EC of 1037.7 tCO_{2e}. They were followed by the P1 model with a total EC of about 1223.2 tCO_{2e}, while the P3 model contributes the highest carbon emissions with a total EC of 1338.9 tCO_{2e}.

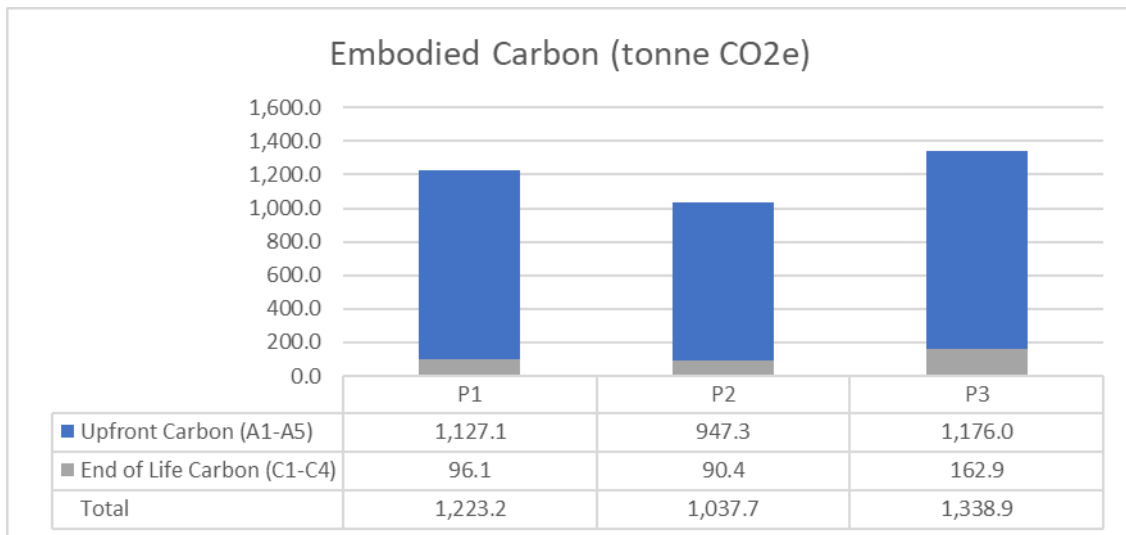

Figure 45: Calculated Embodied Carbon Contribution of models P1, P2, P3.

It could be assumed that a glulam frame would contain a lower embodied carbon due to timbers' inherent capability of absorbing CO₂ (Prentice et al. 2021). Many studies such as Hafner and Schäfer (2018), Spear et al. (2019) and Hart, D'Amico & Pomponi (2021) have respectively observed a potential 9–56% EC reduction in timber-based materials compared to mineral substitutes, a possible 20% EC reduction by substituting masonry with timber frames and a potential 43% EC reduction by use of timber frames compared to concrete and steel frames; the reduction or potential reduction is achieved by the inclusion of sequestered carbon in the results. Although it might appear that the findings of this study do not align with such studies, to avoid the risk of misleading results, a carbon-neutral calculation approach is assumed for wood-based materials (Hoxha 2020).

The embodied carbon of the different components between the three models, as depicted in Table 35, highlights the contribution of each component to the EC. As demonstrated, the inclusion of sequestered carbon can make a significant impact on the total EC. However, the sequestered carbon could only be considered as a carbon-saving measure if the retainment of

the sequestered carbon can be guaranteed. Reusing the material, which would guarantee the captured carbon's retainment, falls under the D stage (beyond the system) (Figure 57) and beyond the scope of WLC assessments and this study. In this assessment, including the negative carbon value, with the assumption of reuse would mean that the carbon saving attribute could not be applied in the material's future life cycles (Jones 2021). Considering the carbon storage of the glulam timber frame reduces the EC of P3 by 67.2 tCO₂e to 1271.7tCO₂e. As seen in Figure 58, this model still contributes the highest carbon emissions.

Table 35: Calculated Embodied Carbon Contribution of the external wall, roof frame & column components of models P1, P2, and P3.

Model	Building Component	Embodied Carbon (kgCO ₂ e)		
		A1-A5	C1-C4	Total
P1, P2	Steel roof frame	36,935.17	5100.46	42,035.63
P3	Glulam Roof frame (without carbon storage)	35,567.46	77,090.24	112,657.70
P3	Glulam Roof frame (with carbon storage)	-31,563.84	77,090.24	45,526.40
P1, P2	Steel columns	8,986.13	16904.48	25,890.61
P3	Pre-cast concrete columns	29,280.04	2,284.65	31,564.69
P1	Cladding Panel Walls	702,514.48	18,298.05	720,812.53
P2	Poroton Walls	523,475.48	12,431.26	535,906.74
P3	Precast Concrete Walls	736,606.64	14,525.38	751,132.02

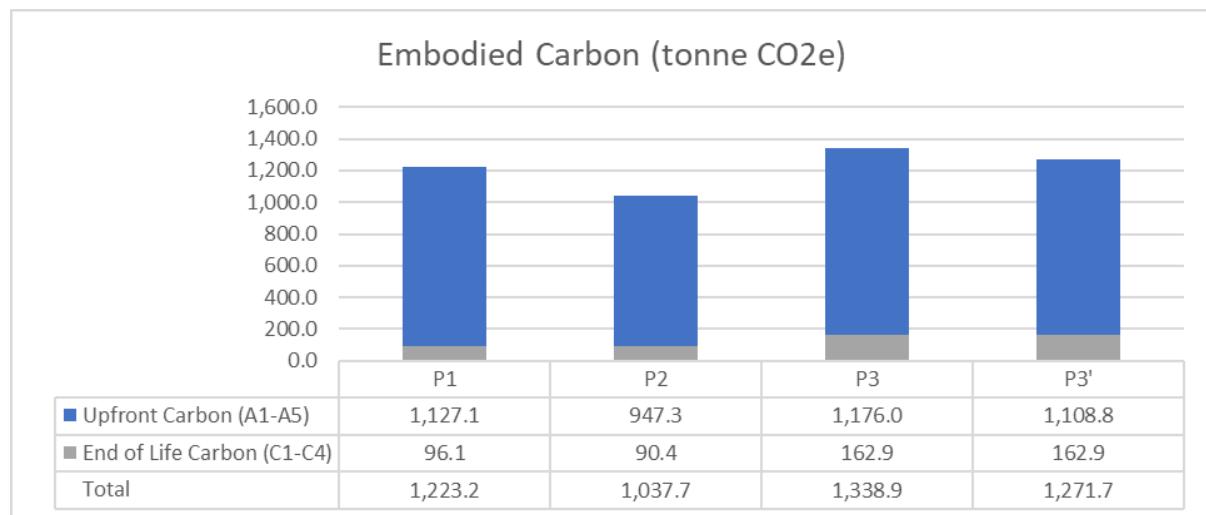

Figure 46: Calculated Embodied Carbon Comparison of models P1, P2, P3, P3' (including timber sequestered carbon).

8.4.2 Operational Energy/Carbon

8.4.2.1 Current Scenario

To calculate the operational energy and carbon emissions of the supermarket building located in Norwich, the CIBSE Test Reference Year (TRY) for Norwich has been used. The annual energy consumption (kWh/m²) and annual CO₂ emissions (kg/m²) of P1, P2 and P3 were calculated within the defined parameters (Figure 59) using the Norwich current TRY files. The operational phase of models P1, P2 and P3 are nearly identical; however, model P3 consumes slightly less energy and produces fewer emissions.

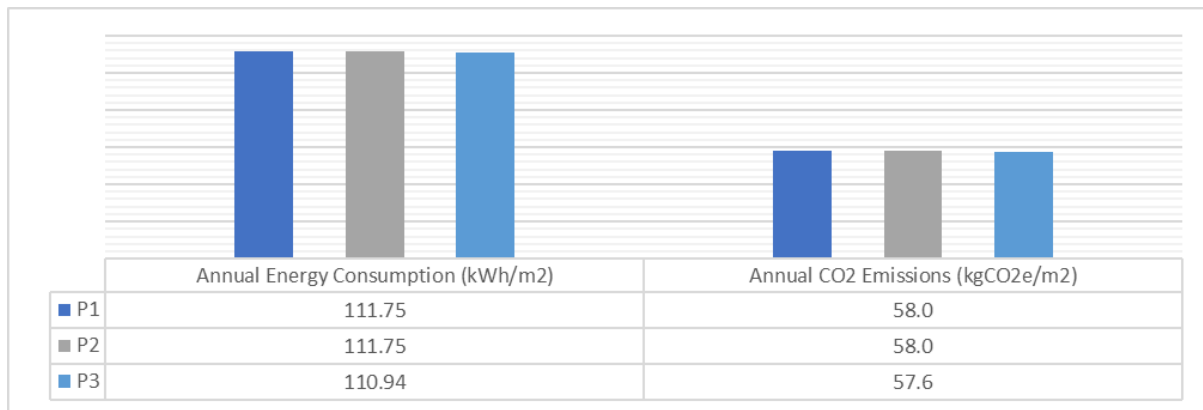

Figure 47: Operational energy and carbon emissions of models P1, P2 and P3 under the current scenario.

These results indicate the energy consumption and subsequent carbon emissions from controlled, fixed building services and fittings, including space heating and cooling, hot water, ventilation and lighting. However, energy consumption from processes that are not controlled, which TAS categorises as equipment use, cannot be considered towards the total energy consumption. These processes, such as IT equipment, lift, escalators, refrigeration systems, external lighting, and small power equipment, depend on user/customer actions, which cannot be predicted and can vary throughout the lifecycle of the building.

8.4.2.2 Future Scenario (20-year period)

As mentioned, the observed service life for this study is 20 years. If the supermarket building's energy consumption and associated carbon emissions remain the same for the next 20 years, the results based on using the current TRY obtained in section 9.3.2.2 are then multiplied by 20 to obtain projections of future energy usage. Retaining the remaining factors, the annual energy consumption and carbon emissions of the next two decades of P1, P2 and P3 were calculated. While this assumption creates some limitations and uncertainty, it provides a valid benchmark comparison for all three models. Adjusting for future changes using CIBSE emission scenarios of the 2050s (low, medium, and high, each with 10th, 50th and 90th percentile) would produce unclear and confusing results for any given model under investigation. It would not provide results for this study's purposes.

As expected, the results in Figure 60 show the nearly identical annual energy consumption and carbon emissions of all three models for the next two decades, with P1 and P2 consuming 5,587,500 kWh of energy and P3 consuming 5,547,000 kWh. And P1 and P2 produce 2,900,000 kgCO₂, and P3 produces 2,880,000 kgCO₂ of carbon emissions. They highlight that even small differences could make a significant difference due to the number of operational emissions. As seen in the 20 tonnes of carbon emissions difference between models P1 and P2 with P3.

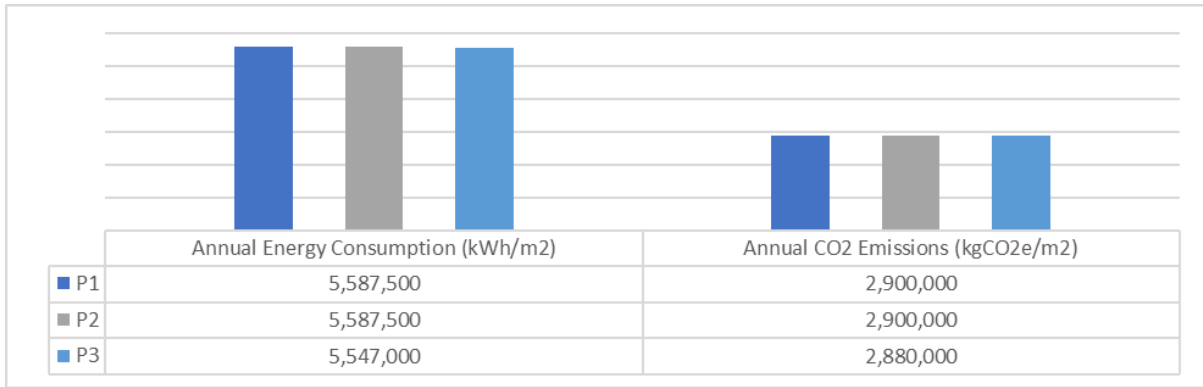

Figure 48: Operational energy and carbon emissions of models P1, P2, and P3 under the future scenario.

As the national grid primarily powers supermarket stores, it is also important to understand the decarbonisation of this energy system which means moving from a centralised, fossil fuel-dependent system to a green and renewable energy system (Groves et al. 2021). In 2021 a landmark commitment to decarbonise the UK’s electricity system by 2035 was confirmed by the UK government by introducing a ten-point via home-grown, green technologies (Vella 2021). However, at this moment, no further explanatory notes or details are available from official sources.

8.4.2.2 Verifying simulation results.

There are distinct possibilities of differences between simulation results and actual building performance due to the use of different assessors, different tools, unknown data, or uncertain information such as user activity, with certain studies suggesting a possibility of an energy performance gap as high as 30% (Tronchin & Fabbri 2010). Therefore, it is important to investigate the reliability of the simulation results. The reliability of the TAS simulation results was tested by validating the results against the measured energy consumption of a LIDL supermarket building of similar proportions and building performance operation in the UK. According to survey and real-time annual energy measurements recorded over five consecutive years, a consumption range of 137.31 kWh/m² to 150.53 kWh/m² was observed. These values are slightly higher than the 111.75 kWh/m² calculated using TAS. However, these differences are affected by various factors such as the exact location of the building, weather database difference and historical climate change, dissimilar HVAC systems, air infiltration systems, as well as the use of TAS instead of Simplified Building Energy Model (SBEM) methodology carried out by independent commercial assessors.

8.4.3 Benchmarking results

It is important to have the exact corresponding values to benchmark the results against the nominal values of a notional building of a similar size. A notional building is a theoretical design of a compliant specification. It is intended to aid designers in showing how compliance might be achieved using certain technologies or u-values. The operational carbon energy and emissions of a notional building would consume approximately 109 kWh/m² and produce 53 kgCO₂/m² depending upon the model type used.

As previously mentioned, the need for more regulation and significantly fewer case studies for embodied carbon prohibits the ability to create a benchmark comparison value. The London

Energy Transformation Initiative (LETI) published a design guide in 2020 providing some data for residential, commercial office and school buildings suggesting that the latter would produce approximately 1000 kgCO₂e/m² in the A1-A5 stages, with a reduction goal of 600 kgCO₂e/m² (LETI 2020). The case studies in this research produced between 378.92 kgCO₂e/m² and 470.39 kgCO₂e/m². However, a Built Environment Carbon Database (BECD) is being developed by several bodies including RIBA, the RICS, CIBSE, BRE, CIOB, IStructE, and ICE which will soft launch in 2023, which could be a vital tool for future research (Fiske 2022).

8.4.4 Whole Life Carbon

To examine the whole life carbon of the three models, the operational carbon, adjusted for the 2,500m² floor area of the building, and the embodied carbon were consolidated. It can be observed that the Whole Life Carbon (WLC), as depicted in Figure 61, follow the same trend as the embodied and operational carbon individually. Model P2 has the lowest WLC of 3,937.7 tonneCO₂e, followed by model P1 with a 4,123.2 tonneCO₂e WLC impact and P3 with the highest impact, with a WLC of 4,218.9 tonneCO₂e. Moreover, even considering the sequestered carbon, the WLC of P3' is still higher than the WLC of P1 and P2, with a value of 4,151.7 tonneCO₂e.

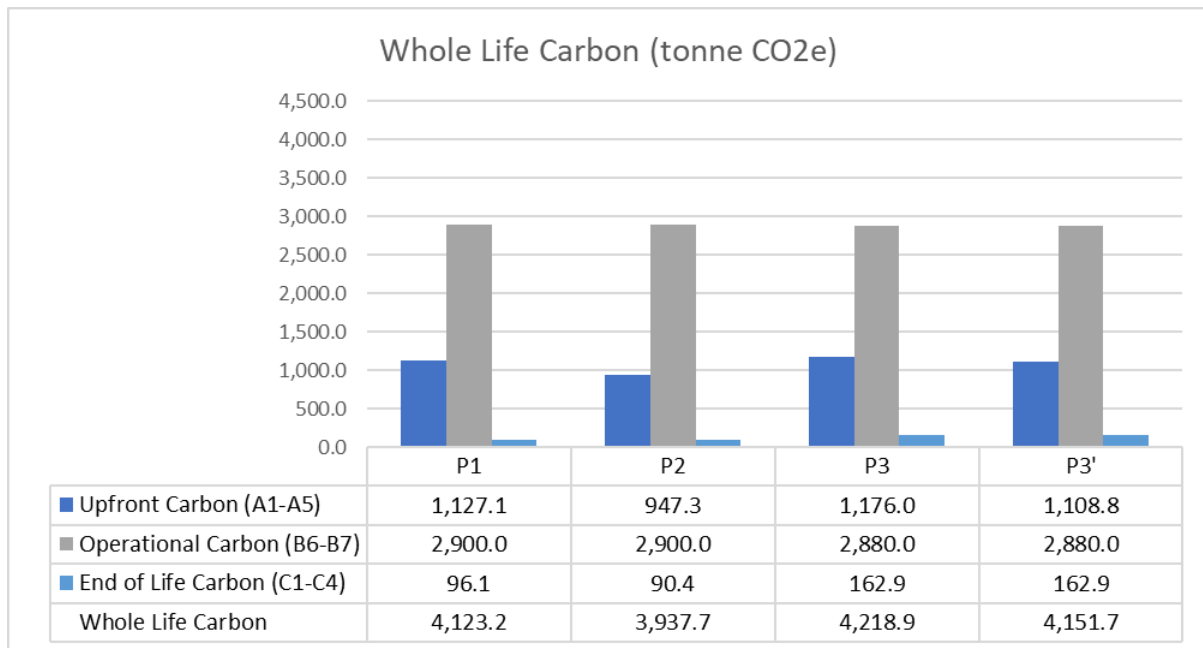

Figure 49: The upfront, operational and end-of-life emissions contribution of models P1, P2, P3, P3'.

We examine the embodied and operational carbon separately, providing insight into the reasons for performing a WLC assessment. The percentage breakdown depicted in Figure 62 shows that the presentation of WLC within this format could be misleading without providing the vital context of the results. Whilst the results of this study present a comparison where the Operational Carbon (OC) has minimal difference between the three models, in other studies, this may result in a misplaced focus on reduction efforts.

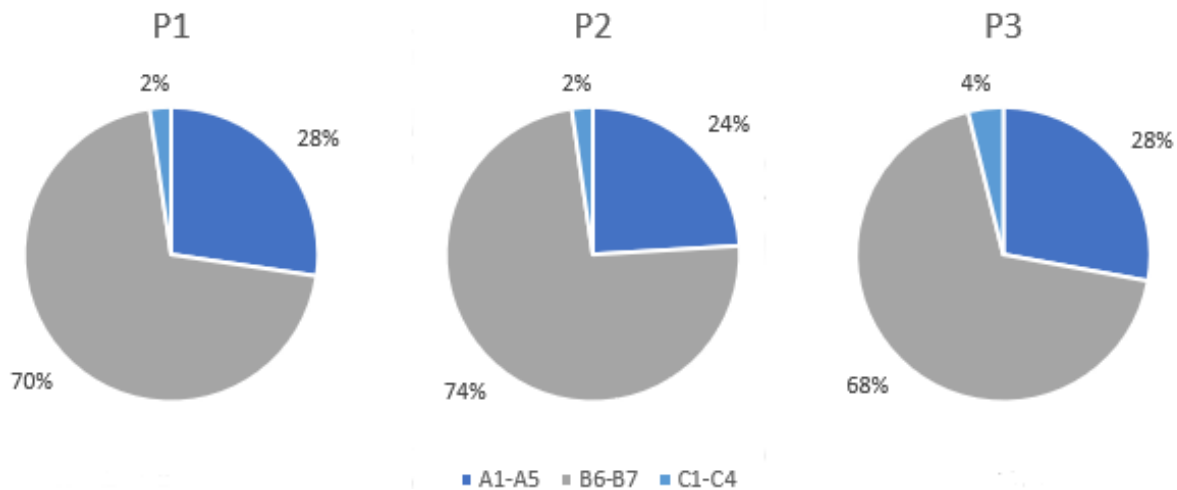

Figure 50: Contributions of the upfront, operational, and end-of-life emissions of models P1, P2, and P3 to the Whole life carbon.

The factors contributing to the largest portions of the OC, such as lighting, are considered negligible when calculating the EC. Consequently, while it might be expected that the building fabric, the largest single contributor to the EC in all three models, contributing 30% of P1, 26% of P2 and 32% of P3's EC, would affect the OC of the buildings. The nature of the building use and the subsequent energy use breakdown, and where all three models are designed with the same HVAC system as presented in this study, factors such as building fabric that significantly affect the difference in EC do not affect the OC substantially. Observing each factor's effects on each stage's emissions separately would provide more accurate information, which would be ideal for future environmental impact reduction efforts. However, adopting this conclusion outside the parameters of this case study would not be practical. As mentioned, one of the possible factors of this result is the specific design and use of the building. These results can also inform future WLC reduction strategies that could be implemented. As the variable factors in this study affecting the environmental impact of each stage are observable, changes to any factor to reduce the impact of any stage can be considered with the knowledge of the effect on the WLC. Furthermore, this study provides a framework for the future study of the non-variable factors between the three models, such as the building design, HVAC system, and the effects on the whole life carbon and further reduction efforts.

8.5 Summary of Findings

This research undertook a comprehensive examination of building materials and construction developments by contrasting the embodied (EC) and operational carbon (OC) emissions across three distinct construction approaches. The life cycle phases scrutinized spanned production, construction, operation, and disposal (A1-A5, B6-B7, C1-C4). A case study of a typical UK supermarket building was employed to evaluate these three construction methodologies, each utilizing different building materials. The findings revealed:

- The P1 model exhibited a whole life cycle (WLC) emission of 4,123 tonneCO₂e, with EC contributing 30%.

- The P2 model demonstrated a WLC emission of 3,938 tonneCO_{2e}, with EC accounting for 26%.
- Preliminary calculations using Revit and TAS tools indicated that the P3 model had the highest WLC emission at 4,219 tonneCO_{2e}, marking a 32% increase in EC, excluding biogenic carbon.

The study's insights suggest that carbon emissions from supermarket buildings can be curtailed by approximately 6.6% through judicious material selection, without necessitating radical redesigns or alterations to building systems. Moreover, since all three structures were conceptualized with uniform building services, the embodied carbon reduction strategy had a minimal impact on operational carbon.

Future research avenues could delve into the potential reduction of OC by integrating alternative building structures and gauging the repercussions of such strategies on EC. These findings are instrumental for designers and engineers, guiding them towards holistic carbon emission reduction strategies. The insights also underscore the importance of WLC considerations in design decisions, especially given the legislative void surrounding many processes, notably the end-of-life phase.

The study accentuates the need for a deeper understanding of carbon savings, urging a look beyond the lifecycle. It paves the way for more informed design decisions, promoting a reduction in carbon emissions across building portfolios. Emphasizing the urgency of future-proofing buildings against climatic shifts, the research advocates for the adoption of passive design technologies and high-efficiency HVAC systems, presenting a pragmatic blueprint to fortify the built environment against anticipated climatic changes.

Chapter 9 - Findings Leading to Recommendations/Conclusions

9.1 Summary of Work

In this thesis, we aimed to investigate the impact of climate change on non-residential building performance, focusing specifically on typical UK supermarkets. To address gaps in the existing literature, we formulated several research questions, including the direct climate change's effect on supermarket construction performance, comparative performance across different regions, energy-efficient measures for carbon emission reduction, and the future implications of operational versus embodied carbon. We aimed to reduce energy consumption and carbon footprint, design, and model building performance, define an nZEB framework, and devise a full life cycle assessment analysis.

A comprehensive investigation was undertaken to meet the set objectives, which involved data analysis and dynamic simulations. An extensive literature review was conducted, followed by an examination of the impact of future climate change on supermarket building performance and a comparison of regional performance. Energy-efficient measures, capable of reducing carbon emissions and energy consumption, were identified. Subsequently, a full life cycle assessment analysis of supermarket buildings was carried out. Our research has yielded valuable insights into the topic. In this concluding chapter, we summarise our findings, provide recommendations for improving the current situation of non-domestic buildings in the UK, and discuss the implications of our work for sustainable building design and operation. By addressing the research questions and achieving our objectives, we have shed light on the challenges and opportunities for reducing the impact of climate change on non-residential buildings.

Our work provides a foundation for future research and practical insights for policymakers and industry stakeholders. The research questions we aimed to address were carefully selected to address the identified gaps in the literature related to non-domestic buildings in the UK. The research questions outlined initially have been addressed throughout this work. Below is a summary of the findings.

- I. What is the direct impact of climate change on the building performance of a typical supermarket in the UK?

Our first research question sought to investigate the direct impact of climate change on the building performance of a typical UK-based supermarket. Through our in-depth research and analysis, we were able to identify the potential impact of future climate change on the building performance of supermarkets and provide recommendations for reducing the associated carbon emissions.

- II. How does the building performance of typical supermarkets compare with each other in different regions of the UK under future climate change?

Our second research question aimed to compare the building performance of typical UK-based supermarkets in different regions under future climate change. Through our comparative study, we identified significant differences in building performance based on location, highlighting the need for region-specific solutions.

III. What types of EEMs could be realistically applied to reduce energy consumption and carbon emissions in non-residential buildings to achieve the nZEB standards?

The third research question focused on identifying realistic energy-efficient measures that could be implemented to achieve the nearly zero energy (nZEB) standards in non-residential buildings. Our analysis revealed that several proven energy-saving techniques could be implemented to reduce energy consumption and carbon emissions in such buildings.

IV. What are the future implications of operational vs embodied carbon of building services of a UK-based supermarket?

Finally, our fourth research question aimed to investigate the future implications of operational versus embodied carbon of building services in a UK-based supermarket. Our analysis revealed that both operational and embodied carbon of building services are significant contributors to carbon emissions in such buildings and underscore the need for a comprehensive approach to carbon reduction. Based on our findings, we recommend that policymakers, industry stakeholders, and building owners take immediate action to improve the current situation of non-domestic buildings in the UK. This includes implementing energy-efficient measures, such as using renewable energy sources and passive design strategies, to reduce energy consumption and carbon emissions. It is also critical that regional-specific solutions are developed to account for the varying impact of climate change on building performance across the UK. Overall, our research provides valuable insights into the challenges and opportunities facing the non-domestic building sector in the UK and highlights the need for continued research and action to improve building performance and reduce carbon emissions.

9.2 Summary of Findings

a) Impacts of Future Climate Change on Supermarket Building Performance

Chapter 4's case study examined the prospective effects of future climate change on the building performance of a typical British supermarket. The findings indicate that future climate change will significantly impact the building performance, specifically on the heating and cooling loads of the building. The results show that the heating load is projected to decrease while the cooling load is projected to increase. Additionally, the study found that implementing energy-efficient measures (EEMs) can substantially reduce the building's energy consumption and carbon emissions.

b) Comparative Study of Supermarket Building Performance under Current and Future Weather Conditions

Chapter 5 conducted a comparative study of the building performance of typical UK supermarkets under current and future weather conditions. The study found that the current building stock is not designed to withstand future climate change impacts. The results show that under future climate change conditions, the energy demand of the building will increase, increasing carbon emissions. The study also compared the building performance of different supermarket types in different regions of the UK. The results show that the building performance of supermarkets in colder regions is better than those in warmer regions.

c) Quantitative Assessment of Supermarket Building Performance about Future Climate Change and Modern Construction Techniques

Chapter 6 provided a quantitative evaluation of the performance of supermarket structures in the United Kingdom regarding future climate change and modern construction techniques. (MMCs). The study discovered that MMCs could substantially reduce a building's energy consumption and carbon emissions. The results show that the application of MMCs can reduce the energy consumption of the building by up to 50% compared to traditional construction techniques. The study also found that adopting MMCs can improve the thermal performance of the building, resulting in a more comfortable indoor environment for occupants.

d) Impact of Energy Efficient Measures (EEMs) on the Operational Performance of a Newly Built London Supermarket

Chapter 7 investigated the impact of energy-efficient measures (EEMs) on the operational performance of a newly built London supermarket. The study found that applying EEMs can significantly reduce the building's energy consumption and carbon emissions. The results show that the energy consumption of the building can be reduced by up to 30% through the application of EEMs. The study also found that adopting EEMs can improve the indoor environmental quality of the building, resulting in a more comfortable indoor environment for occupants.

e) Comparative Analysis of the Whole Life Carbon of Three Construction Methods of a UK-Based Supermarket.

Chapter 8 analysed the whole-life carbon emissions of three construction methods for a British supermarket. According to the study, the building's embodied carbon significantly contributes to its total carbon emissions. The results show that using sustainable materials and construction techniques can significantly reduce the embodied carbon of the building. The study also found that the operational carbon emissions of the building can be reduced through the application of energy-efficient measures (EEMs).

9.3 Implications of the Findings

The findings of this study have significant implications for the operational and embodied carbon of UK-based supermarket buildings, as well as for future design and construction practices.

a) Operational and Embodied Carbon Implications

The results of Chapters 4, 5, and 6 highlight the significant impact climate change can have on the operational carbon emissions of UK supermarkets. The simulations in these chapters show that future weather patterns will likely lead to increased energy consumption and carbon emissions. This suggests that UK supermarkets must implement energy-efficient measures to reduce their carbon footprint.

Chapter 7 examines the impact of energy-efficient measures on the operational performance of a newly built London supermarket. The findings demonstrate that the building reduced its energy consumption and carbon emissions significantly by implementing energy-efficient measures. This highlights the importance of incorporating sustainable design features into new supermarket buildings to ensure energy efficiency and low carbon.

Chapter 8 explores the embodied carbon implications of different construction methods for UK-based supermarket buildings. The findings indicate that traditional construction methods have a significantly higher embodied carbon than modern methods, such as modular construction. This highlights the potential for reducing the embodied carbon of new supermarket buildings by adopting innovative construction techniques. Overall, the findings of this study underscore the importance of reducing operational and embodied carbon emissions in UK supermarket buildings to mitigate the impacts of climate change.

b) Implications for Future Design and Construction

The findings of this study also have important implications for future design and construction practices in the UK supermarket sector. Chapter 4 shows that climate change will significantly impact the performance of supermarket buildings in the future. This suggests that future design and construction practices must consider the potential impacts of climate change to ensure that new buildings are resilient and able to perform under changing weather conditions.

Chapter 5 compares the building performance of UK supermarkets under current and future weather conditions. The results suggest that future supermarket buildings must be designed to be energy-efficient and capable of adapting to changing weather patterns. This highlights the need for designers and architects to incorporate sustainable design features, such as high-performance insulation and energy-efficient lighting, into new supermarket buildings.

Chapter 6 provides a quantitative assessment of the performance of UK supermarket buildings regarding future climate change and modern construction techniques. The findings suggest that adopting modern construction techniques, such as modular construction, can significantly reduce the carbon footprint of new supermarket buildings. This highlights the potential for innovative construction practices to drive sustainability in the UK supermarket sector. Overall, the findings of this study suggest that future design and construction practices in the UK supermarket sector must prioritise sustainability and climate resilience to ensure that new buildings can perform under changing weather conditions while reducing their carbon footprint.

9.4 Limitations

Despite the significant findings of this study, several limitations need to be acknowledged. Firstly, the study used case studies of only a few UK-based supermarkets. Although the supermarkets were selected to represent a diverse range of locations and building types, the sample size is still relatively small. Therefore, the findings may only be generalisable to some UK supermarkets or non-residential buildings.

Secondly, the study focused primarily on the impact of climate change on building performance, specifically energy consumption and carbon emissions. Other aspects of building performance, such as indoor air quality, occupant comfort, and productivity, should have been examined in detail. Further research is needed to investigate the impact of climate change on these aspects of building performance.

Thirdly, the study relied on simulation models to predict the performance of the buildings under future climate conditions. While simulation models are widely used in building performance analysis, there still needs to be some degree of uncertainty associated with the accuracy of the models. Therefore, the results should be interpreted with caution. To address the limitations identified above, the following recommendations for future research are suggested:

- a) Expand the sample size: Future research should include a larger sample size of UK supermarkets and non-residential buildings to increase the generalizability of the findings.
- b) Investigate other aspects of building performance: Future research should consider other aspects of building performance, such as indoor air quality, occupant comfort, and productivity, to gain a more comprehensive understanding of the impact of climate change on building performance.
- c) Validate simulation models: Future research should aim to validate simulation models by comparing predicted building performance with actual building performance data.
- d) Investigate the impact of new technologies: Future research should investigate the impact of new technologies, such as building-integrated photovoltaics (BIPV), energy storage systems, and smart building systems, on building performance under future climate conditions.
- e) Investigate the impact of policy interventions: Future research should investigate the impact of policy interventions, such as building codes and standards, on building performance and climate change mitigation. Overall, this study contributes to the growing body of research on the impact of climate change on building performance and the mitigation of climate change in the UK. However, further research is needed to build on these findings and address the abovementioned limitations. By doing so, we can better understand the implications of climate change for building design and construction in the UK and develop effective strategies for mitigating the impact of climate change on non-residential buildings.

Based on the findings of this research, the following recommendations are proposed to improve the current situation of non-domestic buildings in the UK:

a) Increase the adoption of energy-efficient measures: The research findings suggest that the implementation of energy-efficient measures can positively impact the operational performance of non-residential buildings. Therefore, it is recommended that the adoption of energy-efficient measures be increased to reduce energy consumption and carbon emissions in non-domestic buildings.

b) Increase awareness and education: To improve the current situation of non-domestic buildings in the UK, it is recommended to increase awareness and education on the impact of climate change and the benefits of energy-efficient measures. This can be achieved through government-led campaigns and educational programs.

c) Encourage the use of renewable energy: To further reduce energy consumption and carbon emissions in non-domestic buildings, it is recommended that using renewable energy be encouraged. This can be achieved by implementing policies and incentives to promote the installation of renewable energy sources.

d) Increase research and development: The research highlighted certain limitations that need to be addressed in future research. Therefore, it is recommended that more research be conducted to address these limitations and further improve the understanding of climate change's impact on non-domestic buildings.

e) Strengthen building codes and regulations: To ensure that new and existing non-domestic buildings meet energy efficiency standards, it is recommended that building codes and regulations be strengthened. This can be achieved by implementing stricter energy performance standards and regular building inspections.

9.6 Conclusion

This thesis has investigated the impact of climate change on the building performance of non-residential buildings in the United Kingdom, specifically supermarkets. The research aimed to investigate the potential impact of climate change on the building performance of supermarkets, compare the building performance of typical UK supermarkets under different future weather conditions, assess the performance of UK supermarket buildings to future climate change and modern construction techniques, assess the impact of energy efficient measures on the operational performance of a newly built London supermarket, and compare the operational performance of a newly built London supermarket with the operational performance of a typical UK supermarket.

The research findings suggest that climate change is expected to significantly impact the building performance of non-residential buildings in the UK, particularly supermarkets. The research also highlights that implementing energy-efficient measures can positively impact the operational performance of non-residential buildings, reducing energy consumption and carbon emissions.

The impact of climate change on non-domestic buildings, specifically supermarkets, in the UK is significant. However, the findings of this research suggest that the implementation of energy-efficient measures can positively impact the operational performance of non-residential

buildings. Therefore, it is recommended that the adoption of energy-efficient measures be increased, awareness and education on the impact of climate change and the benefits of energy-efficient measures be increased, the use of renewable energy be encouraged, more research be conducted, and building codes and regulations be strengthened to improve the current situation of non-domestic buildings in the UK.

References:

1. A. and EC, B., (1979). Generation of typical meteorological years for 26 SOLMET stations.
2. Aerts, J. and Botzen, W., (2011). Climate change impacts on pricing long-term flood insurance: A comprehensive study for the Netherlands. *Global Environmental Change*, 21(3), pp.1045-1060.
3. Ahmed, A., Korres, N., Ploennigs, J., Elhadi, H. and Menzel, K., (2011). Mining building performance data for energy-efficient operation. *Advanced Engineering Informatics*, 25(2), pp.341-354.
4. Allen, A., (2015). Commercial building disclosure review. *A report to the Department of Industry and Science*.
5. Alwan, Z. and Jones, P., (2014). The importance of embodied energy in carbon footprint assessment. *Structural Survey*, 32(1), pp.49-60.
6. Alwetaishi, M., (2019). Impact of glazing to wall ratio in various climatic regions: A case study. *Journal of King Saud University - Engineering Sciences*, 31(1), pp.6-18.
7. Alwetaishi, M., Kamel, M. and Al-Bustami, N., (2019). Sustainable applications of asphalt mix with reclaimed asphalt pavement (RAP) materials: innovative and new building brick. *International Journal of Low-Carbon Technologies*, 14(3), pp.364-374.
8. Amiri, A., Emami, N., Ottelin, J., Sorvari, J., Marteinsson, B., Heinonen, J. and Junnila, S., (2021). Embodied emissions of buildings - A forgotten factor in green building certificates. *Energy and Buildings*, 241, pp.110-962.
9. Amoako-Attah, J. and B-Jahromi, A., (2013). Impact of future climate change on UK building performance. *Advances in environmental research*, 2(3), pp.203-227.
10. Amoako-Attah, J. and B-Jahromi, A., (2016). The impact of different weather files on London detached residential building performance—deterministic, uncertainty, and sensitivity analysis on CIBSE TM48 and Cibse TM49 future weather variables using CIBSE TM52 as overheating criteria. *Sustainability*, 8(11), pp. 1194. doi:10.3390/su8111194.
11. Anderson, C.H. and Burns, D.J., (1996). Retailing: Concepts, Strategy and Implementation. *Journal of Retailing and Consumer Services*, 3(3), pp.190-191.
12. Andrić, I., Koc, M. and Al-Ghamdi, S., (2019). A review of climate change implications for built environment: Impacts, mitigation measures and associated challenges in developed and developing countries. *Journal of Cleaner Production*, 211, pp.83-102.
13. Andrić, I., Pina, A., Ferrão, P., Fournier, J., Lacarrière, B. and Le Corre, O., (2017). The impact of climate change on building heat demand in different climate types. *Energy and Buildings*, 149, pp.225-234.
14. ASHRAE (American Society of Heating, Refrigerating and Air-Conditioning Engineers), (1997). Fundamentals, American Society of Heating. *Refrigeration, and Air Conditioning Engineers, Atlanta, Georgia*. Available at: https://www.academia.edu/10884294/ASHRAE_handbook_fundamental
15. Assaf, S. and Nour, M., (2015). Potential of energy and water efficiency improvement in Abu Dhabi's building sector – Analysis of Estidama pearl rating system. *Renewable Energy*, 82, pp.100-107.

16. Atanda, J.O., (2019). Developing a social sustainability assessment framework. *Sustainable Cities and Society*, 44, pp.237-252.
17. Austrian Energy Agency (AEA) (2018). *EPBD implementation in Austria*. Available at: https://ec.europa.eu/energy/sites/default/files/documents/austria-nzeb_en_version_2018.pdf. (Accessed on 20th Dec 2022).
18. Bahadori-Jahromi, A., Rotimi, A., Mylona, A., Godfrey, P. and Cook, D., (2017). Impact of window films on the overall energy consumption of existing UK hotel buildings. *Sustainability*, 9(5), pp.731.
19. Bai, L., Yang, L. and Song, B., (2019). The impact of climate change on thermal climate zones and residential energy efficiency designs during the past decades in China. *Advances in Building Energy Research*, 14(3), pp.389-402.
20. Bamdad, K., Cholette, M., Omrani, S. and Bell, J., (2021). Future energy-optimised buildings — Addressing the impact of climate change on buildings. *Energy and Buildings*, 231, pp.110-610.
21. Barclays, M., Sharples, S., Kang, J. and Watkins, R., (2012). The natural ventilation performance of buildings under alternative future weather projections. *Building Services Engineering Research and Technology* (Sage Publication Ltd.), 33(1), pp. 35-50.
22. BEIS (The Department for Business, Energy and Industrial Strategy). (2016). Building Energy Efficiency Survey, Retail sector 2014-15. Available at: <https://www.gov.uk/government/publications/building-energyefficiency-survey-bees> (Accessed 23 May 2021).
23. Belcher, S., Hacker, J. and Powell, D., (2005). Constructing design weather data for future climates. *Building Services Engineering Research and Technology*, 26(1), pp.49-61.
24. Berardi, U., (2017). A cross-country comparison of the building energy consumptions and their trends. *Resources, Conservation and Recycling*, 123, pp.230-241.
25. Berger, T., Amann, C., Formayer, H., Korjenic, A., Pospichal, B., Neururer, C. and Smutny, R., (2016). Impacts of external insulation and reduced internal heat loads upon energy demand of offices in the context of climate change in Vienna, Austria. *Journal of Building Engineering*, 5, pp.86-95.
26. Berggren, B., Wall, M., Flodberg, K. and Sandberg, E., (2012). Net ZEB office in Sweden – A case study, testing the Swedish Net ZEB definition. *International Journal of Sustainable Built Environment*, 1(2), pp.217-226.
27. Bordass, B., Cohen, R., Standeven, M. and Leaman, A., (2001). Assessing building performance in use 3: energy performance of the Probe buildings. *Building Research & Information*, 29(2), pp.114-128.
28. Borgstein, E., Lamberts, R. and Hensen, J., (2016). Evaluating energy performance in non-domestic buildings: A review. *Energy and Buildings*, 128, pp.734-755.
29. Borgstein, E., Lamberts, R. and Hensen, J., (2016). Evaluating energy performance in non-domestic buildings: A review. *Energy and Buildings*, 128, pp.734-755.
30. Braun, M.R., Beck, S.B.M., Walton, P. and Mayfield, M., (2016). Estimating the impact of climate change and local operational procedures on energy use in several supermarkets throughout Great Britain. *Energy and Buildings*, 111, pp.109-119.
31. BREEAM - Sustainability Assessment Method |. (2022). How BREEAM Certification Works | BREEAM - Sustainability Assessment Method. [online] Available at: <https://www.breeam.com/discover/how-breeam-certification-works/> (Accessed 30 June 2022).

32. British standards institution, Technical Committee B/558 S of construction works, British Standards Institution, European Committee for Standardization. *Environmental management - life cycle assessment - principles and framework (BS EN ISO14040:2006+A1:2020)*. BSI Standards Publication; 2006.
33. British Standards Institution. *Buildings and constructed assets, service life planning, Part 1, General principles and framework*. 2nd ed. Genève: BSI Standards Publication, 2011.
34. Bsria.com. (2022). *BREEAM or LEED - strengths and weaknesses of the two main environmental assessment methods*. [online] Available at: <https://www.bsria.com/uk/news/article/breeam-or-leed-strengths-and-weaknesses-of-the-two-main-environmental-assessment-methods/> (Accessed 18 February 2022).
35. *Building and Environment*, (2017). IFC - Ed. Board. 119, p.IFC.
36. Cabeza, L., Chàfer, M. and Mata, É., (2020). Comparative Analysis of Web of Science and Scopus on the Energy Efficiency and Climate Impact of Buildings. *Energies*, 13(2), pp.409.
37. Calleja Rodríguez, G., Carrillo Andrés, A., Domínguez Muñoz, F., Cejudo López, J. and Zhang, Y., (2013). Uncertainties and sensitivity analysis in building energy simulation using macroparameters. *Energy and Buildings*, 67, pp.79-87.
38. Campagna, L. and Fiorito, F., (2022). On the Impact of Climate Change on Building Energy Consumptions: A Meta-Analysis. *Energies*, 15(1), pp.354.
39. CCA Climate Change Act. (2008). Available at: https://www.legislation.gov.uk/ukpga/2008/27/pdfs/ukpga_20080027_en.pdf (Accessed 23 May 2021).
40. Cellura, M., Guarino, F., Longo, S. and Tumminia, G., (2018). Climate change and the building sector: Modelling and energy implications to an office building in southern Europe. *Energy for Sustainable Development*, 45, pp.46-65.
41. Chan, A., (2011). Developing future hourly weather files for studying the impact of climate change on building energy performance in Hong Kong. *Energy and Buildings*, 43(10), pp.2860-2868.
42. Chartered Institute of Building (CIOB) - CIOB CarbonAction2050.com.2018. facts and figures. Available at: http://www.carbonaction2050.com/sites/carbonaction2050.com/files/document/attachment/STATISTICS%20-%20CarbonAction2050_0.pdf (Accessed 15 November 2021).
43. Ciancio, V., Falasca, S., Golasi, I., Curci, G., Coppi, M. and Salata, F., (2018). Influence of Input Climatic Data on Simulations of Annual Energy Needs of a Building: EnergyPlus and WRF Modeling for a Case Study in Rome (Italy). *Energies*, 11(10), pp.2835.
44. Ciancio, V., Salata, F., Falasca, S., Curci, G., Golasi, I. and de Wilde, P., (2020), "Energy demands of buildings in the framework of climate change: An investigation across Europe. Sustainable Cities and Society", *Sustain Cities Soc.*, 60, pp102-213.
45. CIBSE (Chartered Institute of Building Services Engineers)., (2017). CIBSE Weather Data Sets. Cibse, London, UK. Available at: <http://www.cibse.org.uk/knowledge/cibse-weather-data-sets> (Accessed 30 October 2022).
46. CIBSE Guide J: Weather, Solar and Illuminance data. (2002). The Chartered Institution of Building Services Engineers, London. Available

- at:<https://www.cibse.org/knowledge/knowledge-items/detail?id=a0q3Y00000Hj0hmQAB> (Accessed 30 November 2021).
47. CIBSE. (2006). Design, E. and Guide, A., Chartered institute of building services engineers. Available at: <https://www.cibse.org/knowledge/knowledge-items/detail?id=a0q20000008I72rAAC> (Accessed 30 May 2022).
 48. CIBSE. (2008). TM46: Energy Benchmarks, London: The Chartered Institution of Building Services Engineers.
 49. CIBSE. (2015). AM11 Building performance modelling (2015). Available at: <https://www.cibse.org/Knowledge/knowledgeitems/detail?id=a0q20000008JeYXAA0> (Accessed 15 May 2021).
 50. CIBSE., (1998). Applications Manual AM11: Building energy and environmental modelling (*London: Chartered Institute of Buildings Services Engineers*) ISBN 0 900953 85 3.
 51. Clarke, J. and Irving, A., (1988). Building energy simulation: An introduction. *Energy and Buildings*, 10(3), pp.157-159.
 52. Çomaklı, K. and Yüksel, B., (2004). Environmental impact of thermal insulation thickness in buildings. *Applied Thermal Engineering*, 24(5-6), pp.933-940.
 53. Council of Australian Governments (COAG). (2012). Baseline energy consumption and greenhouse gas emissions in commercial buildings in Australia <https://industry.gov.au/Energy/EnergyEfficiency/NonresidentialBuildings/Documents/CBBS-Part-1.pdf> (Accessed 15 March 2021).
 54. Crawley, D.B., (2006). Impact of climate change on buildings. In Proceedings of the CIBSE/ASHRAE international conference.
 55. Crawley, D.B., Hand, J.W., Kummert, M. and Griffith, B.T., (2008). Contrasting the capabilities of building energy performance simulation programs. *Building and Environment*, 43(4), pp.661-673.
 56. D'Agostino, D., Tzeiranaki, S., Zangheri, P. and Bertoldi, P., (2021). Assessing Nearly Zero Energy Buildings (NZEBs) development in Europe. *Energy Strategy Reviews*, 36, pp.100-680.
 57. Daly, D., Cooper, P. and Ma, Z., (2014). Implications of global warming for commercial building retrofitting in Australian cities. *Building and Environment*, 74, pp.86-95.
 58. DCLG - The Department for Levelling Up, Housing and Communities. (2020). Available at: <http://www.communities.gov.uk> (Accessed 20 May 2021).
 59. DCLG - The Department for Levelling Up, Housing and Communities., (2020). Available at: <http://www.communities.gov.uk> (Accessed 23 January 2021).
 60. De Alegría Mancisidor, I., Díaz de Basurto Uraga, P., Martínez de Alegría Mancisidor, I. and Ruiz de Arbulo López, P., (2009). European Union's renewable energy sources and energy efficiency policy review: The Spanish perspective. *Renewable and Sustainable Energy Reviews*, 13(1), pp.100-114.
 61. De Wilde, P. and Coley, D., (2012). The implications of a changing climate for buildings. *Building and Environment*, 55, pp.1-7.
 62. De Wilde, P., (2014). The gap between predicted and measured energy performance of buildings: A framework for investigation. *Automation in Construction*, 41, pp.40-49.
 63. DECC (The Department of Energy and Climate Change), (2013). Non-domestic building energy use project. Phase I, Pilot study of the food and mixed retail sector. Retrieved from:

- https://assets.publishing.service.gov.uk/government/uploads/system/uploads/attachment_data/file/207319/DECC_Non-domestic_building_energy_use_project_phase_I.pdf (Accessed 15 October 2021).
64. DEFRA (Department for Environment, Food and Rural Affairs). (2007). UK Government Sustainable Procurement Action Plan: Incorporating the Government response to the report of the Sustainable Procurement Task Force. London: HMSO.
 65. Demanuele, C., Tweddell, T. and Davies, M., (2010), September. Bridging the gap between predicted and actual energy performance in schools. In *World renewable energy congress XI* (pp. 25-30). UAE Abu Dhabi.
 66. Deng, S., Wang, R.Z. and Dai, Y.J., (2014). How to evaluate performance of net zero energy building – A literature research. *Energy*, 71, pp.1–16.
 67. DesignBuilder Software Ltd. Available at: <http://www.designbuilder.co.uk> (Accessed on 08 April 2022).
 68. Dimoudi, A. and Tompa, C., (2008). Energy and environmental indicators related to construction of office buildings. *Resources, Conservation and Recycling*, 53(1-2), pp.86-95.
 69. Dodoo, A. and Gustavsson, L., (2016). Energy use and overheating risk of Swedish multi-storey residential buildings under different climate scenarios. *Energy*, 97, pp.534-548.
 70. Dott, R., Haller, M.Y., Ruschenburg, J., Ochs, F. and Bony, J., (2013). The reference framework for system simulations of the IEA SHC Task 44/HPP Annex 38 Part B: buildings and space heat load. *International Energy Agency*.
 71. Dudkiewicz, E. and Fidorów-Kaprawy, N., (2017). The energy analysis of a hybrid hot tap water preparation system based on renewable and waste sources. *Energy*, 127, pp.198-208.
 72. Eames, M., Kershaw, T. and Coley, D., (2010). On the creation of future probabilistic design weather years from UKCP09. *Building Services Engineering Research and Technology*, 32(2), pp.127-142.
 73. Eames, M., Ramallo-Gonzalez, A. and Wood, M., (2015). An update of the UK's test reference year: The implications of a revised climate on building design. *Building Services Engineering Research and Technology*, 37(3), pp.316-333.
 74. EDGE Buildings. (2022). *Certification - EDGE Buildings*. [online] Available at: <https://edgebuildings.com/certify/certification/> (Accessed 13 July 2022).
 75. EDSL TAS., (2020). Software Package for the Thermal Analysis of Buildings. [online]. Available at: <http://www.edsl.net/main/Support/Documentation.aspx> (Accessed 10 January 2021).
 76. ELLA - Green building in Latin America. (2018). Available at: https://assets.publishing.service.gov.uk/media/57a08a07e5274a31e00003aa/131106_ENV_TheGreEco_BRIEF1.pdf (Accessed 15 September 2022)
 77. Eltges, M., (2010). Leipzig Charter on Sustainable European Cities – A Work in Progress. *European Spatial Research and Policy*, 16(2), pp.63-78.
 78. EMSD. (2019). Residential-energy utilization index. Available at: https://ecib.emsd.gov.hk/en/indicator_rdt.htm (Accessed 15 September 2021).
 79. Energy Market Authority (EMA) Singapore energy statistics. (2016). Available at: https://www.ema.gov.sg/cmsmedia/Publications_and_Statistics/Publications/ses/2016/energy-consumption/index.html (Accessed 15 June 2021).

80. EnergyPlus Energy Simulation Software, United States Department of Energy. Available at: <http://www.eere.energy.gov/buildings/energyplus> (Accessed 10 May 2022).
81. Environment Bureau of Hong Kong (EBHK), Energy Saving Plan for Hong Kong's Built Environment. (2015). Available at: <https://policy.asiapacificenergy.org/node/2925> (Accessed 15 August 2022).
82. Environment Canada. (2013). Canada's emissions trends. Available at: <https://www.ec.gc.ca/ges-ghg/985F05FB-4744-4269-8C1A-D443F8A86814/1001-Canada%27s%20Emissions%20Trends%202013e.pdf> (Accessed 15 January 2021).
83. Everblue Training. (2022). *What is LEED Certification?* [online] Available at: <https://everbluetraining.com/leed/certification/> (Accessed 16 February 2022).
84. Fan, C., Sun, Y., Shan, K., Xiao, F. and Wang, J., (2018). Discovering gradual patterns in building operations for improving building energy efficiency. *Applied Energy*, 224, pp.116-123.
85. Farah, S., Whaley, D., Saman, W. and Boland, J., (2019). Integrating climate change into meteorological weather data for building energy simulation. *Energy and Buildings*, 183, pp.749-760.
86. Fedoruk, L., Cole, R., Robinson, J. and Cayuela, A., (2015). Learning from failure: understanding the anticipated–achieved building energy performance gap. *Building Research & Information*, 43(6), pp.750-763.
87. Fernández, J.C.R. and Roqueñí, N., (2018). Analysis of the potential of Spanish supermarkets to contribute to the mitigation of climate change. *Sustainable Production and Consumption*, 14, pp.122-128.
88. Foster, A., Evans, J. and Maidment, G.G., (2018), April. Benchmarking of supermarket energy consumption. In *5th International Institute of Refrigeration Conference on Sustainability and the Cold Chain*. IIR.
89. Gaterell, M.R. and McEvoy, M.E., (2005). The impact of climate change uncertainties on the performance of energy efficiency measures applied to dwellings. *Energy and buildings*, 37(9), pp.982-995.
90. GOV.UK. (2012). National Statistics, Energy consumption in the UK. Retrieved from: <https://www.gov.uk/government/statistics/energyconsumption-in-the-uk> (Accessed 15 July 2021).
91. Guan, L., (2009). Implication of global warming on air-conditioned office buildings in Australia. *Building Research & Information*, 37(1), pp.43-54.
92. Guan, L., (2009). Preparation of future weather data to study the impact of climate change on buildings. *Building and Environment*, 44(4), pp.793-800.
93. Guggenberger, J.D., Elmore, A.C. and Crow, M.L., (2013). Predicting the performance of a renewable energy-powered microgrid throughout the United States using typical meteorological year 3 data. *Renewable Energy*, 55, pp.189-195. DOI: 10.1016/j.renene.2012.12.001
94. Gullo, P., Hafner, A. and Banasiak, K., (2018). Transcritical R744 refrigeration systems for supermarket applications: Current status and future perspectives. *International Journal of Refrigeration*, 93, pp.269-310.
95. Gustavsson, L., Joelsson, A. and Sathre, R., (2010). Life cycle primary energy use and carbon emission of an eight-storey wood-framed apartment building. *Energy and buildings*, 42(2), pp.230-242.

96. Hacker, J.N., De Saullers, T.P., Minson, A.J. and Holmes, M.J., (2008). Embodied and operational carbon dioxide emissions from housing: A case study on the effects of thermal mass and climate change, *Energy Build.*, 40(3), pp. 375-384.
97. Hacker, J.N., Holmes, M., Belcher, S. and Davies, G., (2005). Climate change and indoor environment: impacts and adaptation, The Chartered Institution of Building Services Engineers, London.
98. Hall, I.J., HE, Hall, I.J., HE, A. and EC, B., (1979). Generation of typical meteorological years for 26 SOLMET stations.
99. Hamdy, M., Carlucci, S., Hoes, P. and Hensen, J., (2017). The impact of climate change on the overheating risk in dwellings—A Dutch case study. *Building and Environment*, 122, pp.307-323.
100. Harris, G.R., Sexton, D.M., Booth, B.B., Collins, M. and Murphy, J.M., (2013). Probabilistic projections of transient climate change. *Climate dynamics*, 40(11), pp.2937-2972.
101. Hasan, A., Bahadori-Jahromi, A., Mylona, A., Ferri, M. and Tahayori, H., (2020). Investigating the potential impact of future climate change on UK supermarket building performance. *Sustainability*, 13(1), pp.33.
102. Herrando, M., Cambra, D., Navarro, M., de la Cruz, L., Millán, G. and Zabalza, I., (2016). Energy Performance Certification of Faculty Buildings in Spain: The gap between estimated and real energy consumption. *Energy Conversion and Management*, 125, pp.141-153.
103. Hevacomp Software Ltd. Available online: <http://www.hevacomp.com> (Accessed on 08 January 2022).
104. Hitchin, E., Holmes, M., Hutt, B., Irving, S. and Nevrala, D., (1983). The CIBS example weather year. *Building Services Engineering Research and Technology*, 4(3), pp.119-124.
105. Huang, K., Wang, J. and Wang, Y., (2015). Analysis and benchmarking of greenhouse gas emissions of luxury hotels. *International Journal of Hospitality Management*, 51, pp.56-66.
106. IEA (The International Energy Agency)., (2006). World Energy Outlook 2006, IEA, Paris. Available at: <https://www.iea.org/reports/world-energy-outlook-2006> (Accessed 23 March 2021).
107. IEA, I. and BERG, T., (2015). Building Energy Use in China: Transforming Construction and Influencing Consumption to 2050. *Paris, France: International Energy Agency*.
108. IES Virtual Environment, Integrated Environmental Solutions Ltd. Available at: <http://www.iesve.com> (Accessed on 08 March 2022).
109. IPCC (Intergovernmental Panel on Climate Change)., (2014). Climate change 2014: synthesis report. [online]. Available at: <http://www.ipcc.ch/publications> (Accessed 23 November 2021).
110. IPCC (Intergovernmental Panel on Climate Change)., (2018). Summary for policymakers. In: Global Warming of 1.5°C (*Geneva: World Meteorological Organization and United Nations Environment Programme*), pp. 18.
111. IPCC (The Intergovernmental Panel on Climate Change), (2007). Climate Change 2007: The Physical Science Basis, London, U.K. Available at: <https://www.ipcc.ch/report/ar4/wg1/> (Accessed 23 June 2021).
112. IPCC, 2022: Climate Change 2022: Impacts, Adaptation, and Vulnerability. Contribution of Working Group II to the Sixth Assessment Report of the

- Intergovernmental Panel on Climate Change [H.-O. Pörtner, D.C. Roberts, M. Tignor, E.S. Poloczanska, K. Mintenbeck, A. Alegría, M. Craig, S. Langsdorf, S. Lösschke, V. Möller, A. Okem, B. Rama (eds.)]. Cambridge University Press. Cambridge University Press, Cambridge, UK and New York, NY, USA, 3056 pp., doi:10.1017/9781009325844.
113. Jentsch, M.F., Bahaj, A.S. and James, P.A., (2008). Climate change future proofing of buildings—Generation and assessment of building simulation weather files. *Energy and Buildings*, 40(12), pp.2148-2168.
 114. Jeong, J., Hong, T., Ji, C., Kim, J., Lee, M. and Jeong, K., (2016). Development of an evaluation process for green and non-green buildings focused on energy performance of G-SEED and LEED. *Building and Environment*, 105, pp.172-184.
 115. Ji, Y., Lee, A. and Swan, W., (2019). Building dynamic thermal model calibration using the Energy House facility at Salford. *Energy and Buildings*, 191, pp.224-234.
 116. Jiang, A., Liu, X., Czarnecki, E. and Zhang, C., (2019). Hourly weather data projection due to climate change for impact assessment on building and infrastructure. *Sustainable Cities and Society*, 50, pp.101-688.
 117. Jing, R., Wang, M., Zhang, R., Li, N. and Zhao, Y., (2017). A study on energy performance of 30 commercial office buildings in Hong Kong. *Energy and Buildings*, 144, pp.117-128.
 118. Jradi, M., Arendt, K., Sangogboye, F.C., Mattera, C.G., Markoska, E., Kjærgaard, M.B., Veje, C.T. and Jørgensen, B.N., (2018). ObepME: An online building energy performance monitoring and evaluation tool to reduce energy performance gaps. *Energy and Buildings*, 166, pp.196-209.
 119. Kang, D. and Strand, R., (2019). Analysis of the system response of a spray passive downdraft evaporative cooling system. *Building and Environment*, 157, pp.101-111.
 120. Kendon, M., McCarthy, M., Jevrejeva, S., Matthews, A., Sparks, T. and Garforth, J., (2020). State of the UK Climate 2019. *International Journal of Climatology*, 40, pp.1-69.
 121. Kendon, M., McCarthy, M., Jevrejeva, S., Matthews, A., Sparks, T. and Garforth, J., (2020). State of the UK Climate 2019. *International Journal of Climatology*, 40, pp.1-69.
 122. Kershaw, T., Eames, M. and Coley, D., (2011). Assessing the risk of climate change for buildings: A comparison between multi-year and probabilistic reference year simulations. *Building and Environment*, 46(6), pp.1303-1308.
 123. Kočí, J., Kočí, V., Maděra, J. and Černý, R., (2019). Effect of applied weather data sets in simulation of building energy demands: Comparison of design years with recent weather data. *Renewable and Sustainable Energy Reviews*, 100, pp.22-32.
 124. Köhler, J., Geels, F.W., Kern, F., Markard, J., Onsongo, E., Wieczorek, A., Alkemade, F., Avelino, F., Bergek, A., Boons, F. and Fünfschilling, L., (2019). An agenda for sustainability transitions research: State of the art and future directions. *Environmental innovation and societal transitions*, 31, pp.1-32.
 125. Kolokotroni, M., Mylona, Z., Evans, J., Foster, A. and Liddiard, R., (2019). Supermarket Energy Use in the UK. *Energy Procedia*, 161, pp.325-332.
 126. Kolokotsa, D., (2016). The role of smart grids in the building sector. *Energy and Buildings*, 116, pp.703-708.

127. Lam, J., (2000). Energy analysis of commercial buildings in subtropical climates. *Building and Environment*, 35(1), pp.19-26.
128. Leskinen, N., Vimpari, J. and Junnila, S., (2020). A Review of the Impact of Green Building Certification on the Cash Flows and Values of Commercial Properties. *Sustainability*, 12(7), pp.27-29.
129. Levermore, G. and Parkinson, J., (2006). Analyses and algorithms for new Test Reference Years and Design Summer Years for the UK. *Building Services Engineering Research and Technology*, 27(4), pp.311-325.
130. Li, D.H., Yang, L. and Lam, J.C., (2012). Impact of climate change on energy use in the built environment in different climate zones—a review. *Energy*, 42(1), pp.103-112.
131. Li, Y., Kubicki, S., Guerriero, A. and Rezgui, Y., (2019). Review of building energy performance certification schemes towards future improvement. *Renewable and Sustainable Energy Reviews*, 113, pp.109-244.
132. Lin, N. and Liu, F., (2012). Green Low Carbon Design in the Application of Energy-Saving Building. *Advanced Materials Research*, 512-515, pp.2878-2881.
133. Liobikienė, G. and Butkus, M., (2019). Scale, composition, and technique effects through which economic growth, foreign direct investment, urbanization, and trade affect greenhouse gas emissions. *Renewable Energy*, 132, pp.1310-1322.
134. Lomas, K.J. and Ji, Y., (2009). Resilience of naturally ventilated buildings to climate change: Advanced natural ventilation and hospital wards, *Energy Build.*, 41(6), pp. 629-653.
135. Lomas, K.J. and Porritt, S.M., (2017). Overheating in buildings: lessons from research. *Building Research & Information*, 45(1-2), pp.1-18.
136. Loveland, J. and Brown, G.Z., (1996). Impacts of climate change on the energy performance of buildings in the United States.
137. Manz, H., Loutzenhiser, P., Frank, T., Strachan, P., Bundi, R. and Maxwell, G., (2006). Series of experiments for empirical validation of solar gain modelling in building energy simulation codes—Experimental setup, test cell characterization, specifications and uncertainty analysis. *Building and Environment*, 41(12), pp.1784-1797.
138. Markard, J. and Hoffmann, V., (2016). Analysis of complementarities: Framework and examples from the energy transition. *Technological Forecasting and Social Change*, 111, pp.63-75.
139. Masson-Delmotte, V., Zhai, P., Pirani, A., Connors, S.L., Péan, C., Berger, S., Caud, N., Chen, Y., Goldfarb, L., Gomis, M.I. and Huang, M., (2021). Climate change 2021: the physical science basis. *Contribution of working group I to the sixth assessment report of the intergovernmental panel on climate change*, pp.2.
140. Mavrogianni, A., Davies, M., Batty, M., Belcher, S.E., Bohnenstengel, S.I., Carruthers, D., Chalabi, Z., Croxford, B., Demanuele, C., Evans, S. and Giridharan, R., (2011). The comfort, energy and health implications of London's urban heat island. *Building Services Engineering Research and Technology*, 32(1), pp.35-52.
141. McMichael, A.J., Woodruff, R.E. and Hales, S., (2006). Climate change and human health: present and future risks. *The Lancet*, 367(9513), pp.859-869.
142. Menezes, A., Cripps, A., Bouchlaghem, D. and Buswell, R., (2012). Predicted vs actual energy performance of non-domestic buildings: Using post-occupancy evaluation data to reduce the performance gap. *Applied Energy*, 97, pp.355-364.

143. Met Office. (2021). *UK regional climates*. Available online: <https://www.metoffice.gov.uk/research/climate/maps-and-data/regional-climates/index> (accessed on 08 April 2021).
144. Minea, V., (2010). Improvements of high-temperature drying heat pumps. *International Journal of Refrigeration*, 33(1), pp.180-195.
145. Moazami, A., Carlucci, S., Nik, V.M. and Geving, S., (2019). Towards climate robust buildings: An innovative method for designing buildings with robust energy performance under climate change. *Energy and Buildings*, 202, pp.109-378.
146. Moazami, A., Nik, V., Carlucci, S. and Geving, S., (2019). Impacts of future weather data typology on building energy performance – Investigating long-term patterns of climate change and extreme weather conditions. *Applied Energy*, 238, pp.696-720.
147. Morel, J., Mesbah, A., Oggero, M. and Walker, P., (2001). Building houses with local materials: means to drastically reduce the environmental impact of construction. *Building and Environment*, 36(10), pp.1119-1126.
148. Nakicenovic, N., Grübler, A., Gaffin, S., Jung, T., Kram, T., Morita, T., Pitcher, H., Riahi, K., Schlesinger, M., Shukla, P., van Vuuren, D., Davis, G., Michaelis, L., Swart, R. and Victor, N., (2003). IPCC Sres Revisited: A Response. *Energy & Environment*, 14(2-3), pp.187-214.
149. National Energy Efficiency Action Plans NEEAPs., (2017). *28 April 2017: UK 2017 National Energy Efficiency Action Plan and Annual Report*. Available at: https://ec.europa.eu/energy/sites/ener/files/documents/uk_neeap_2017.pdf (Accessed 23 July 2021).
150. Nicol, F. and Humphreys, M., (2007). Maximum temperatures in European office buildings to avoid heat discomfort. *Solar Energy*, 81(3), pp.295-304.
151. Norford, L.K., Socolow, R.H., Hsieh, E.S. and Spadaro, G.V., (1994). Two-to-one discrepancy between measured and predicted performance of a 'low-energy office building: insights from a reconciliation based on the DOE-2 model. *Energy and buildings*, 21(2), pp.121-131.
152. Oldewurtel, F., Parisio, A., Jones, C., Gyalistras, D., Gwerder, M., Stauch, V., Lehmann, B. and Morari, M., (2012). Use of model predictive control and weather forecasts for energy efficient building climate control. *Energy and Buildings*, 45, pp.15-27.
153. One Click LCA® software. (2022). *LCA in LEED - Whole-building Life Cycle Assessment*. [online] Available at: <https://www.oneclicklca.com/whole-building-life-cycle-assessment-for-leed-v4-credits/> (Accessed 16 January 2022).
154. One Click LCA® software. (2022). *Read our guide on LCA Green Building Credits for LEED and BREEAM*. [online] Available at: <https://www.oneclicklca.com/lca-credits-green-building-certifications> (Accessed 30 January 2022)..
155. Pacetti, M., Passerini, G., Brebbia, C.A. and Latini, G. eds., (2012). *The Sustainable City VII: Urban Regeneration and Sustainability* (Vol. 155). Wit Press.
156. Pan, W. and Garmston, H., (2012). Building regulations in energy efficiency: Compliance in England and Wales. *Energy Policy*, 45, pp.594-605.
157. Panao, M.J.O., Camelo, S.M. and Gonçalves, H.J., (2011). Assessment of the Portuguese building thermal code: Newly revised requirements for cooling energy needs used to prevent the overheating of buildings in the summer. *Energy*, 36(5), pp.3262-3271.

158. Pathan, A., Mavrogianni, A., Summerfield, A., Oreszczyn, T. and Davies, M., (2017). Monitoring summer indoor overheating in the London housing stock. *Energy and Buildings*, 141, pp.361-378.
159. PDR (The British Property Federation Report)., (2017). Property Data Report. Available at: <https://www.bpf.org.uk/sites/default/files/resources/PIA-Property-Data-Report-2017.pdf> (Accessed 23 June 2021).
160. Pegg, I., Cripps, A. and Kolokotroni, M., (2005). A Post-Occupancy Evaluation of a Low Energy School (City Academy) in the UK. *International Journal of Ventilation*, 4(3), pp.215-225.
161. Peng, C., (2016). Calculation of a building's life cycle carbon emissions based on Ecotect and building information modelling. *Journal of Cleaner Production*, 112, pp. 453–465.
162. Petri, Y. and Caldeira, K., (2015). Impacts of global warming on residential heating and cooling degree-days in the United States. *Scientific Reports*, 5(1), pp.1-14.
163. Picard, T., Hong, T., Luo, N., Lee, S. and Sun, K., (2020). Robustness of energy performance of Zero-Net-Energy (ZNE) homes. *Energy and Buildings*, 224, pp.110-251.
164. Pino, A., Bustamante, W., Escobar, R. and Pino, F., (2012). Thermal and lighting behaviour of office buildings in Santiago of Chile. *Energy and Buildings*, 47, pp.441-449.
165. Priyadarsini, R., Hien, W. and Wai David, C., (2008). Microclimatic modelling of the urban thermal environment of Singapore to mitigate urban heat island. *Solar Energy*, 82(8), pp.727-745.
166. *PROBE*- archive held by the Usable Buildings Trust (UBT). <http://www.usablebuildings.co.uk/Pages/UBProbePublications1.html> (Accessed 30 April 2022).
167. Radhi, H., (2009). Evaluating the potential impact of global warming on the UAE residential buildings – A contribution to reduce the CO₂ emissions. *Building and Environment*, 44(12), pp.2451-2462.
168. Raftery, P., Keane, M. and O'Donnell, J., (2011). Calibrating whole building energy models: An evidence-based methodology. *Energy and Buildings*, 43(9), pp.2356-2364.
169. Rahman, I. and Dewsbury, J., (2007). Selection of typical weather data (test reference years) for Subang, Malaysia. *Building and Environment*, 42(10), pp.3636-3641.
170. Ramesh, T., Prakash, R. and Shukla, K., (2010). Life cycle energy analysis of buildings: An overview. *Energy and Buildings*, 42(10), pp.1592-1600.
171. Randall, D., Wood, R., Bony, S., Colman, R., Fichefet, T., Fyfe, J., Kattsov, V., Pitman, A., Shukla, J., Srinivasan, J. and Stouffer, R., (2007). Climate Models and Their Evaluation, chapter 8. *Climate Change 2007: The Physical Science Basis.*, pp.589-662.
172. Resuli, P. and Dervishi, S., (2015). Thermal Performance of Cultural Heritage Italian Housing in Albania. *Energy Procedia*, 78, pp.753-758.
173. Revi, A., Satterthwaite, D., Aragón-Durand, F., Corfee-Morlot, J., Kiunsi, R.B., Pelling, M., Roberts, D., Solecki, W., Gajjar, S.P. and Sverdlík, A., (2014). Towards transformative adaptation in cities: the IPCC's Fifth Assessment. *Environment and Urbanization*, 26(1), pp.11-28.

174. Robinson, J., Foxon, T. and Taylor, P., (2016). Performance gap analysis case study of a non-domestic building. *Proceedings of the Institution of Civil Engineers - Engineering Sustainability*, 169(1), pp.31-38.
175. Roderick, Y., McEwan, D., Wheatley, C. and Alonso, C., (2009), July. Comparison of energy performance assessment between LEED, BREEAM and Green Star. In *Eleventh international IBPSA conference* (pp. 27-30).
176. Roshan, G., Oji, R. and Attia, S., (2019). Projecting the impact of climate change on design recommendations for residential buildings in Iran. *Building and Environment*, 155, pp.283-297.
177. Roy, C. and Oberkampf, W., (2011). A comprehensive framework for verification, validation, and uncertainty quantification in scientific computing. *Computer Methods in Applied Mechanics and Engineering*, 200(25-28), pp.2131-2144.
178. Sabunas, A. and Kanapickas, A., (2017). Estimation of climate change impact on energy consumption in a residential building in Kaunas, Lithuania, using HEED Software. *Energy Procedia*, 128, pp.92-99.
179. Sadineni, S., Madala, S. and Boehm, R., (2011). Passive building energy savings: A review of building envelope components. *Renewable and Sustainable Energy Reviews*, 15(8), pp.3617-3631.
180. Salata, F., Golasi, I., Verrusio, W., de Lieto Vollaro, E., Cacciafesta, M. and de Lieto Vollaro, A., (2018). On the necessities to analyse the thermohygrometric perception in aged people. A review of indoor thermal comfort, health and energetic aspects and a perspective for future studies. *Sustainable cities and society*, 41, pp.469-480.
181. SBEM, BRE - National Calculation Method, Building Research Establishment Ltd., Watford, (2020). Available online: <http://www.ncm.bre.co.uk> (Accessed 10 December 2021).
182. Schandl, H., Fischer-Kowalski, M., West, J., Giljum, S., Dittrich, M., Eisenmenger, N., Geschke, A., Lieber, M., Wieland, H., Schaffartzik, A. and Krausmann, F., (2018). Global material flows and resource productivity: forty years of evidence. *Journal of Industrial Ecology*, 22(4), pp.827-838.
183. Schweber, L., (2013). The effect of BREEAM on clients and construction professionals. *Building Research & Information*, 41(2), pp.129-145.
184. SDG (Sustainable Development Commission. (2008). *Green, Healthy and Fair: A Review of the Government's Role in Supporting Sustainable Supermarket Food*. SDC, London.
185. Shariq, M. and Hughes, B., (2020). Revolutionising building inspection techniques to meet large-scale energy demands: A review of the state-of-the-art. *Renewable and Sustainable Energy Reviews*, 130, pp.109-979.
186. Shen, P., (2017). Impacts of climate change on U.S. building energy use by using downscaled hourly future weather data. *Energy and Buildings*, 134, pp.61-70.
187. Shibuya, T. and Croxford, B., (2016). The effect of climate change on office building energy consumption in Japan. *Energy and Buildings*, 117, pp.149-159.
188. Strachan, P., Kokogiannakis, G. and Macdonald, I., (2008). History and development of validation with the ESP-r simulation program. *Building and Environment*, 43(4), pp.601-609.
189. Sullivan, R., Gouldson, A., (2013). Ten years of corporate action on climate change: What do we have to show for it? *Energy Policy*, 60, pp. 733–740.

190. Tassou, S.A., Ge, Y., Hadawey, A. and Marriott, D., (2011). Energy consumption and conservation in food retailing. *Applied Thermal Engineering*, 31(2-3), pp.147-156.
191. Thormark, C., (2006). The effect of material choice on the total energy need and recycling potential of a building. *Building and Environment*, 41(8), pp.1019-1026.
192. Tian, W., Heo, Y., de Wilde, P., Li, Z., Yan, D., Park, C., Feng, X. and Augenbroe, G., (2018). A review of uncertainty analysis in building energy assessment. *Renewable and Sustainable Energy Reviews*, 93, pp.285-301.
193. Timma, L., Skudritis, R. and Blumberga, D., (2016). Benchmarking Analysis of Energy Consumption in Supermarkets. *Energy Procedia*, 95, pp.435-438.
194. Tronchin, L. and Fabbri, K., (2010). A Round Robin Test for buildings energy performance in Italy. *Energy and Buildings*, 42(10), pp.1862-1877.
195. UK Climate Projections (UKCP) (2020). MET Office. [online] Available at: <https://www.metoffice.gov.uk/research/approach/collaboration/ukcp/index> (Accessed 30 September 2020).
196. UN (Nations, U)., (2014). World urbanisation prospects: The 2014 revision, highlights. department of economic and social affairs. *Population Division, United Nations*, 32. Available at: <https://www.un.org/en/development/desa/publications/2014-revision-world-urbanization-prospects.html> (Accessed 23 June 2021).
197. Urge-Vorsatz, D., Petrichenko, K., Staniec, M. and Eom, J., (2013). Energy use in buildings in a long-term perspective. *Current Opinion in Environmental Sustainability*, 5(2), pp.141-151.
198. USDA - United States Department of Agriculture (2019), Retail food report, U.S. Available at: <https://apps.fas.usda.gov/newgainapi/api/report> (Accessed 23 March 2021).
199. Van der Sluis, S., Lindberg, U., Lane, A.L. and Arias, J., (2015). Performance indicators for energy-efficient supermarket buildings. In *24th IIR International Congress of Refrigeration, ICR 2015, 16 August 2015 through 22 August 2015* (pp. 2773-2780). International Institute of Refrigeration.
200. van Dronkelaar, C., Dowson, M., Spataru, C. and Mumovic, D., (2016). A Review of the Regulatory Energy Performance Gap and Its Underlying Causes in Non-domestic Buildings. *Frontiers in Mechanical Engineering*, 1.
201. Virk, G., Mylona, A., Mavrogianni, A. and Davies, M., (2015). Using the new CIBSE design summer years to assess overheating in London: Effect of the urban heat island on design. *Building Services Engineering Research and Technology*, 36(2), pp.115-128.
202. Vittorini, D. and Cipollone, R., (2016). Energy saving potential in existing industrial compressors. *Energy*, 102, pp.502-515.
203. Wan, K., Li, D., Pan, W. and Lam, J., (2012). Impact of climate change on building energy use in different climate zones and mitigation and adaptation implications. *Applied Energy*, 97, pp.274-282.
204. Wang, X., Chen, D. and Ren, Z., (2011). Global warming and its implication to emission reduction strategies for residential buildings. *Building and Environment*, 46(4), pp.871-883.

205. Way, M. and Bordass, B., (2005). Making feedback and post-occupancy evaluation routine 2: Soft landings—involving design and building teams in improving performance. *Building Research & Information*, 33(4), pp.353-360.
206. Weißenberger, M., Jensch, W. and Lang, W., (2014). The convergence of life cycle assessment and nearly zero-energy buildings: The case of Germany. *Energy and Buildings*, 76, pp.551-557.
207. Willis, J., Jost, M. and Nilakanta, R., (2009). *Foundations of qualitative research*. Thousand Oaks: SAGE.
208. Yang, L., Yan, H. and Lam, J., (2014). Thermal comfort and building energy consumption implications – A review. *Applied Energy*, 115, pp.164-173.
209. Yudelson, J., (2010). *The green building revolution*. Island Press.
210. Zhai, Z.J. and Helman, J.M., (2019). Implications of climate changes to building energy and design. *Sustainable Cities and Society*, 44, pp.511-519.